



Optical Lab and Manufacturing Test Platform



Table of Contents

MAP System (Multiple Application Platform)	3
MAP-300	4
MAP-220C	14
LightDirect Solutions	19
Optical Sources and Amplifiers	21
Continuously Tunable Laser Source (mTLS-C1)	22
Tunable DBR Laser (mTLG)	26
Broadband Light Source (mBBS)	29
Erbium Doped Fiber Amplifier (mEDFA)	32
Distributed Feedback (DFB) Source Module	37
Fabry Perot (FP) Source Module	40
Light Emitting Diode (LED) Source Module	45
Super-Luminescent Light Emitting Diode (SLED) laser Source Module	48
Semiconductor Optical Amplifier (SOA) Module	52
Optical Signal Conditioning	55
Variable Back Reflector (mVBR-C1)	56
Variable Optical Attenuator (mVOA)	59
Multiport Tunable Filter (mTFX)	64
Polarization Scrambler Controller (mPCX)	71
Optical Signal Switching & Routing	78
Optical Switch Solutions (mOSW/mISW)	79
MAP Optical Switch Solutions	87
Passive Utility Module (mUTL)	90
Cross Connect Optical Switch (mOSX)	95
Optical Power & Spectral Measurement	101
Optical Power Meter (mOPM)	102
High-Resolution Optical Spectrum Analyzer (mHROSA)	108
MAP Series Power Meter Detector Adaptors	110
LightTest Solutions	118
Insertion Loss/Return Loss Testing Solution (mORL)	120
Single Fiber Passive Connector Test (PCT-rm) System for IL/RL (mOLM)	131
Swept Wavelength System (mSWS)	138
Optical Component Environmental Test Systems (mOCETS Plus)	143
On-Site Services	149
PCT Calibration	150
mSWS Calibration	153
OCETS Calibration	156
CleanBlastPRO	159

MAP System (Multiple Application Platform)

The VIAVI Multiple Application Platform (MAP) is an optical test and measurement platform optimized for cost-effective development and manufacturing of optical transmission techniques. They are designed to help manage the test and measurement needs of an industry that requires flexibility and dynamic performance. Our aim is to offer researchers, designers and manufacturing engineers, a platform that outshines all others with its modularity, reliability and flexibility.

The MAP chassis are the foundation to our entire portfolio of modules, enabling scalability and efficiency for manufacturing optical network elements. The cassettes are the building blocks and fall into two different families, the LightTest turn-key solutions and the LightDirect configurable solutions to meet each customer's exact needs.



Third Generation Multiple Application Platform (MAP-300)

The VIAVI Solutions Multiple Application Platform (MAP-300) is an optical test and measurement platform optimized for compact cost-effective development and manufacturing of optical communications technology.

From the original Multiple Application Platform (MAP) system released in 2001 as part of JDSU to the new third generation MAP-300 Series, the MAP system is the heart of the VIAVI optical test solutions for labs and manufacturing. With unmatched scalability, users can be assured that our solutions will meet their current and future needs. MAP-300 provides the foundation to our entire portfolio, enabling scalability and efficiency for manufacturing optical network elements, modules and components.

Customer Focused Innovation

The new MAP-300 builds upon the proven strengths of the MAP System while adding innovation where it matters most for our customers. Backwards compatible support for the installed automation base, combined with several new features, including an HTML-based GUI for multi-user environments, gives our customers the capabilities they need to achieve their goals. We can't wait to see what you will accomplish with the new MAP-300!



Key Features

- Available in rackmount, reverse-rackmount and benchtop mainframe configurations
- HTML-based graphical user interface gives consistent user experience both locally and remotely
- Field-replaceable controller includes an integrated 3.5-inch LCD touchscreen for network and system status
- Support for USB 3.0 port, 15.6-inch external monitor, and ethernet
- Optional GPIB, additional ethernet ports and additional USB and trigger modules
- SCPI logical interface for automation programming, with remote programming supported via TCP/IP (LXI) over ethernet, GPIB and direct socket
- Multi-user capability
- Backward compatible with MAP2xx series cassettes and remote-control support
- Hot swappable modules
- Supports the MAP-Series asset management tool MAPcc

Applications

- General purpose fiber-optic lab use
- Manufacturing test automation
- DWDM/WSS test
- Connectivity IL/RL
- Polarization scrambling and OSNR

Compliance

- MAP Series cassettes include amplifier and source cassettes classified as either Class 3B or Class 1M Laser products. While operating in a MAP Series mainframe, cassettes meet the requirements of the IEC 60825-1 standard and comply with 21 CFR 1040.10 and 1040.11, except for deviations pursuant to Laser Notice 50, dated June 24, 2007.

MAP-300 Configurations

The MAP-300 mainframe, like its predecessor, is offered in both benchtop and rackmount versions as either three or eight slot mainframe configurations. The eight-slot can also provided in a reverse rack-mount configuration.

Benchtop	Rackmount and Reverse-Rackmount
<p>Because each lab bench is unique, the MAP-300 chassis can be flexibly deployed in the space available. Easily stackable with simple, intuitive flip-up feet for easier positioning. The touch screen display's orientation-sensing ability enables positioning the chassis for use vertically or horizontally.</p>	<p>The chassis can be ordered in front- or rear-module entry rackmount configurations (reverse-rackmount only available for the 8-slot chassis). Rackmount configurations ship in kits containing all necessary mounting hardware. Conversion kits are available for mounting benchtop configurations.</p>

MAP-380 Eight-Slot Mainframes

Each MAP-380 mainframe consists of a 3U chassis that can house up to eight cassettes, plus a field-replaceable controller. The MAP-380 mainframe is available in rackmount, reverse-rackmount, and benchtop configurations.



Figure 1 - MAP-380 rackmount and benchtop mainframes front view



Figure 2 - MAP-380 rackmount and benchtop mainframes, rear view



Figure 3 - MAP-380 reverse rackmount mainframes, front and rear view

MAP-330 Three-Slot Mainframes

Each MAP-330 mainframe consists of a 3U chassis that can house up to three cassettes, plus a field-replaceable controller. The rackmount versions are half 19" rack wide, so two units can be mounted side-by-side. An optional touch screen can be docked on the mainframe of a benchtop three-slot chassis for an easy portable, self-contained system.



Figure 4 - MAP-330 benchtop mainframe, front and rear view



Figure 5 - MAP-330 benchtop mainframe with 15.6-inch touchscreen docked, front view



Figure 6 - MAP-330 3U half 19-inch rackmount mainframe, front view

Simple, Intuitive Graphical Controller

The MAP-300 chassis includes a 3.5-inch touch screen that supports intuitive swipes for easy navigation. This local touchscreen provides access to connection and configuration settings.

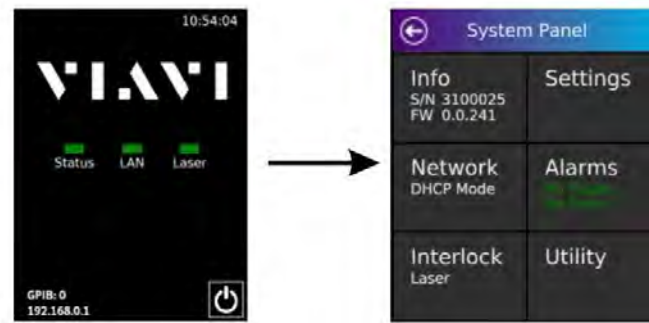

Figure 7 - MAP-300 local touchscreen

Users can access the MAP-300 GUI from a mainframe locally or remotely via Ethernet. The MAP-300 GUI allows multi-user access via a supported web browser by entering the IP address acquired from the controller in the location field of the web browser. The slot configuration of a mainframe is represented by widgets (one per slot) on the MAP-300 dashboard. When a slot is populated, the widget representing that slot identifies the cassette and provides quick access to the main device settings. The user can change the size of the widget to see more detail on specific cassettes. A detailed view of a cassette is available, whilst still having a complete view of all other slots.

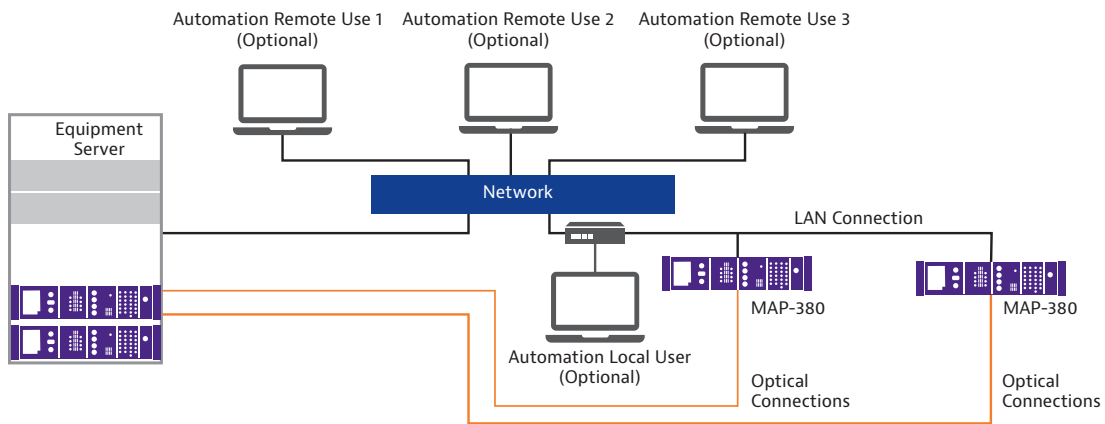

Figure 8 - MAP-380 Dashboard GUI example.

The settings panel gives you access to network and system settings, as well as remote chassis and license settings if available. The MAP-300 can be rebooted or placed in standby mode using through the GUI or local touchscreen.

Control Interfaces

As a full-fledged member of the MAP family, all remote interfaces can interoperate with the three-slot and eight-slot versions. It includes optimized Interchangeable Virtual Instrument (IVI) drivers for ease of use with popular application-development environments, such as LabVIEW, Visual C++, Visual Basic, and LabWindows™, to provide full control of the modules and drop-in instrument programming capabilities. These capabilities let test programmers focus on test-level functions and sequences rather than the details required to communicate with the specific modules in the MAP system. The IVI drivers also include a simulation mode that lets developers capture system configurations so they can perform most of their development offline, freeing hardware for other purposes. These features make test automation development and debugging fast and easy. All MAP series module and platform commands conform to the Standard Commands for Programmable Instruments (SCPI) command language.



Extensive Input/Output Interfaces

All mainframe configurations include:

- Ethernet port for remote communication.
- 4 USB host ports for installing peripheral devices, including USB drives, a mouse, and a keyboard.
- One USB host port for the optional touchscreen.
- Integrated 3.5-inch LCD touchscreen for network and system status information.
- All mainframes can support up to two field-installable additional accessory modules for control and triggering. Available modules include (1) IEEE-488 (GPIB), (2) dual trigger LXI-compliant LDVS driver ports, and (3) three USB 3.0 ports and one Ethernet interface.

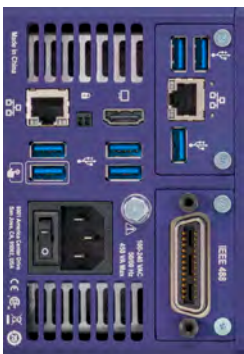

Users who are comfortable with the General Purpose Interface Bus (GPIB) remote interface can order the field-installable option at any time.

MAP Control Center (MAPcc)

VIAMI now offers the MAP Control Center (MAPcc), an asset management tool for MAP mainframes and cassettes. The MAPcc simplifies network management via a single screen that lists a full inventory of all your assets, enabling you to explore internal and external mainframes as well as the cassettes present in those mainframes. From the list of available mainframes, you can retrieve IP addresses, firmware versions and serial numbers, and you can search for a specific type of cassette, fiber or connector. The MAPcc lets you upgrade multiple mainframes at the same time using the upgrade center, as well as retrieve log files.

Model	IP	Hostname	PartNumber	SerialNumber	Version	MfgDate	Slot1	Slot2	Slot3	Slot4	Slot5	Slot6	Slot7	Slot8	Plugin1	Plugin2	Licenses	Tag	Description	Notes
MAP-300	10.14.140.11	8876252-4	MAP-380CH	3100436	7.0.1	4/6/2020														
MAP-200	10.14.140.13		MAP-200	0	5.1.4		BB5	VOA	SDM	OPM										
MAP-200	10.14.140.17	MAP-200-2102	MAP-200	2292	5.3.8		EDFA	UTL	UTL	VOA										
MAP-200	10.14.140.16	MAP-200-2156	MAP-200	2156	7.0.3		SRX	SDM	SDM	SDM										
MAP-200	10.14.140.27	MAP-200-1553	MAP-200	1553	7.0.3				LCS	OPM	OPM	OSW								
MAP-300	10.14.140.26	MAP300-3	MAP-380CH	3100031	7.0.CH176	11/1/2016	VOA	VOA	OSW	UTL	SDM	OPM	EDFA							
MAP-200	10.14.140.44	MAP-200-3207	MAP-200	3207	7.0.3		TLG	SRC	SRC	OSW										
MAP-300	10.14.140.31	MAP300-8	MAP-380CH	3100088	7.0.CH176	4/9/2019	OSW		OSW	OSW										
MAP-200	10.14.140.36	MAP-200-0	MAP-200	20837	5.7.2		VOA	PCX												
MAP-300	10.14.140.34	8876252	MAP-380CH	3100411	6.2.0	3/21/2020	OSW	OSW	OSW	OSW	OPM	OPM								
MAP-220	10.14.140.37	MAP-200CLD	MAP-200CLD-A	01720VC	5.3.3	6/27/2017	SRC	OLM												
MAP-200	10.14.140.49	MAP-200-495	MAP-200	495	7.0.3															
MAP-200	10.14.140.50		MAP-200	352	5.3.11		PCT													
MAP-220	10.14.140.51	MAP-200CLD	MAP-200CLD-A	451631C0C	4.6.16	10/14/2016	BB5													
MAP-300	10.14.140.37	MAP300-15	MAP-380CH	3100031	7.1.CH195	11/26/2018	SDM	SL3		STX										
MAP-300	10.14.140.54	MAP300-7	MAP-380CH	3100100	7.0.CH176	4/21/2019	VOA	VOA	VOA	OPM	BB5	OPM	TL5							
MAP-300	10.14.140.57	MAP300-14	MAP-380CH	3100222	7.1.CH187	7/31/2019	SRC													
MAP-300	10.14.140.97	MAP300-2	MAP-380CH	3100033	7.0.CH176	11/1/2018	SRC	TLG	SRC	SRC	VOA	OSW	SPN	TLG						
MAP-200	10.14.140.98	MAP-200-571	MAP-200	571	5.0.10		OPM	OPM	BB5	VOA			SRC	EDFA	EDFA					
MAP-200	10.14.140.96	MAP-200-8	MAP-200	20176	7.0.3		PCT													
MAP-300	10.14.140.19	MAP-200-20936	MAP-200	20936	5.3.8															
MAP-220	10.14.140.168	MAP-200CLD	PK15467996	S0DD0L123	7.0.6	1/1/2013														
MAP-300	10.14.140.20	MAP-200-20923	MAP-200	20923	5.3.8		PCT													
MAP-220	10.14.140.52	MAP-200CLD	MAP-200CLD-A	451631C1	4.6.16	10/1/2016	VOA	OSW												
MAP-300	10.14.140.104	8876252-5	MAP-380CH	3100266	6.2.0	8/16/2019	PCT	PCT	SRC				UTL	OPM						
MAP-200	10.14.140.109	MAP-200-20033	MAP-200	20033	7.0.3															
MAP-300	10.14.140.111	MAP300-7	MAP-380CH	3100096	7.1.CH195	4/22/2019	LCS			SL3										
MAP-300	10.14.140.113	MAP300-8	MAP-380CH	3100222	5.3.8		SRC	OPM	VOA	VOA										
MAP-300	10.14.140.116	MAP300-4	MAP-380CH	3100035	7.0.CH176	11/1/2016	OSW	OSW	OSW	OSW	OSW									
MAP-220	10.14.140.131	MAP-200CLD	MAP-200CLD-A	45154094	4.6.16	11/1/2015	OPM													
MAP-200	10.14.140.134	MAP-200-963	MAP-200	963	5.3.8					PCX										
MAP-300	10.14.140.138	2H9EY72	MAP-380CH	3100009	7.0.1	11/21/2018	PCT													
MAP-200	10.14.140.148	MAP-200-0	MAP-200	21391	7.0.3		PCT	VOA	VOA	EDSW	LCS	OSW								
MAP-200	10.14.140.131	MAP-200-2156	MAP-200	2156	7.0.3								TTX							
MAP-300	10.14.140.152	MAP300-7	MAP-380CH	3100033	7.1.CH195	3/22/2019	TRX		OSW	OSW	OSW	OSW								
MAP-300	10.14.140.133	MAP300-8	MAP-380CH	3100222	7.0.CH176	8/20/2019	OSX	VOA	OSW	UTL	UTL	UTL	OSW							
MAP-300	10.14.140.137	MAP300-12	MAP-380CH	3100276	7.1.CH190	7/30/2019	TLG	VBR	EDFA	EDFA	EDFA	OSW	PCX	SRC						
MAP-200	10.14.140.139	MAP-200-424	MAP-200	424	7.0.3		SRX	SDM	OSW	OSW	BB5	UTL								
MAP-300	10.14.140.163	8876252-6	MAP-380CH	3100317	7.0.1	11/8/2019														
MAP-220	10.14.140.164	MAP-200CLD	MAP-200CLD-A	45154179	4.6.16	11/1/2015														

MAP Cassette Management

MAP Chassis Details

Chassis | PN: 3100216 | SN: MAP-380CH | FW: 7.1.CH190

Slot	Port	Device	Firmware	PartNumber	SerialNumber	FiberType	ConnectorType	License
0	3100	CMR						
1	8201	TLG	3.0.3	MTLG-CCT1L1				
2	8202	EDFA	1.3.9	MEDFAC1YCF-M100-MFA				
3	8203	VBR	3.1.3	evVBR-C1550-M101-MFP				
4	8204	EDFA	1.3.9	MEDFAC1YCA-M100-MFA				
5	8205	EDFA	1.3.9	MEDFAC1YCA-M100-MFA				
6	8206	EDFA	1.3.9	MEDFAC1YCB-M100-MFA				
7	8207	PCX	1.2.7	MPCX-C115F3-M103-MFA				
8	8208	SRC	3.4.11	MSRC-C20005A-M100-MFA				

IP Address: 10.14.140.157

Device: MAP-300 MAINFRAME

Serial Number: 3100044

Firmware Version: 7.0.0156

Description: MAP300 #12

Inventory Address String: TC190:10.14.20.91::INST0:INST0

MAP Control Center | Upgrade

Type	IP	License	Part Number	Serial Number	Connected	Version	Available	Progress	Status
MAP-200	10.14.140.13		MAP-200		Yes	2.0.4			Done
MAP-300	10.14.140.11		MAP-300		Yes	7.0.1			Done

MAP Chassis Selection Guide

VIAMI offers a variation of chassis, the table below summaries their key attributes of each chassis and why it would be ideal for you.

Chassis	Modular Family	Configuration	Size	Modular	Slots	Controller Touchscreen	Super Apps	Optional Touchscreen	Remote Control	Field Replaceable Controller	Optional Plug-in Modules			
MAP-330	LightDirect and LightTest	Benchtop and Rackmount	3U, 1/2 19" rack	Yes	3	3.5-in touchscreen for network/system controls	Yes	USB 15.6-in display, 1920X1080 resolution. Docks to benchtop	Ethernet	Yes	GPIB, USB/LAN, Expansion, LXI Trigger			
MAP-380		Benchtop, Rackmount and Reverse Rackmount	3U, 19" rack		8							320 X 240 resolution	USB 15.6-in display, 1920X1080 resolution. Does not dock	
MAP-220C	LightDirect Only	Benchtop, Rackmount and Reverse Rackmount	2U, 1/2 19" rack	Yes	2	3.5-in touchscreen that replaces the need for a PC	No	No	Ethernet	Yes	GPIB			
MAP-202C	mISW-C1 Optical Switch only	Benchtop and Rackmount	2U, 1/2 19" rack	No	NA < 75 ports					No		No	Ethernet	No
MAP-204C		Benchtop and Reverse Rackmount	4U, 19" rack		NA < 160 ports									

Specifications

Mainframe Specifications

The table below provides specifications for MAP-300 mainframes. For MAP Series cassettes, refer to the user guide for each cassette.

Parameters	MAP-330	MAP-380
Mainframe Chassis		
Capacity (Single-width cassettes)	3 cassettes	8 cassettes
Rackmount Kit	Optional	
Benchtop Kit	Optional	
Controller (MAP-300CLD-B)		
Operating System	Linux	
Local Touchscreen	3.5-in touchscreen for network/system status controls, 320 x 240 resolution	
Power Supply	100 to 240 V AC, 50/60 Hz, Auto-switching	
Power Consumption	450 VA MAX	450 VA MAX
Field Replaceable	Yes	
Bays for Plug-in Modules	2	
Native Ports/Interfaces		
USB 3.0 Host	1 front	
USB 3.0 (Mouse, Keyboard, etc.)	4 rear	
Ethernet 10/100/1000BASE-T	1 rear	
Monitor port	1 rear	
Optical Plug-in Modules	GPIB, USB/LAN Expansion, Trigger	
Automation		
Driver Type	IVI compliant	
Standard/Protocol	LXI, VXI-11, SCPI	
Driver Compatibility	LabView™, LabWindows™, Microsoft® Visual C++, Microsoft® Visual Basic®	
Accessibility	Multiuser sharing support	
Web GUI Compatibility	Google Chrome, Mozilla Firefox or Microsoft Edge	
Laser Interlock (See the MAP Series Safety and Compliance Reference Guide, 22112369-325, for more information.)		
Local Interlock	Software controlled	
Remote Interlock	2-pin terminal block at rear controller	
Mechanical		
Dimensions of rackmount (W x H x D)	24.61 x 13.26 x 38.63 cm (9.6 x 5.2 x 15.2 in)	48.26 x 13.26 x 38.63 cm (19 x 5.2 x 15.2 in)
Dimensions of benchmount (W x H x D)	26.43 x 15.49 x 44.27 cm (10.4 x 6.1 x 17.5 in)	46.94 x 15.49 x 44.27 cm (18.5 x 6.1 x 17.5 in)
Weight		
Benchtop Mainframe	10 kg (22 lb)	12.6 kg (27.7 lb)
Rackmount Mainframe	7.4 kg (16.3 lb)	10.8 kg (23.8 lb)
Environment		
Operating Temperature	0 to 50°C	
Storage Temperature	-30 to 60°C	
Relative Humidity	5% to 85% non-condensing	

Optional 15.6-inch Touchscreen (MAP-300AKD) Specifications

Parameter	Specification
Dimensions	16-in x 9-in
Resolution	1080p (1920x1080)
Dock to Benchtop Mainframe	
MAP-330	Supported
MAP-380	Not Supported
Power/Interface to Mainframe	
MAP-330	USB cable or docking connector
MAP-380	USB cable
Weight	2.7 kg (5.95 lb)

Ordering Information

For more information on this or other products and their availability, please contact your local VIAVI account manager or VIAVI directly at 1-844-GO-VIAVI (1-844-468-4284) or to reach the VIAVI office nearest you, visit viavisolutions.com/contacts.

MAP-300 Mainframes

Chassis Slot Number	Description	Part Number
Three-Slot Mainframe	MAP-330A 3 Slot 3U 19-in LightTest Basic Mainframe	MAP-330AB-B
	MAP-330A 3 Slot 3U Half 19-in LightTest Benchtop Mainframe	MAP-330A-B
	MAP-330A 3 Slot 3U Half 19-in LightTest Benchtop Mainframe with Touchscreen	MAP-330AD-B
	MAP-330A 3 Slot 3U Half 19-in LightTest Rackmount Mainframe	MAP-330AX-B
Eight-Slot Mainframe	MAP-380A 8 Slot 3U 19-in LightTest Benchtop Mainframe	MAP-380A-B
	MAP-380A 8 Slot 3U 19-in LightTest Rackmount Mainframe	MAP-380AX-B
	MAP-380A 8 Slot 3U 19-in LightTest Reverse Rackmount Mainframe	MAP-380AXR-B

MAP-300 Accessories and Replacement Parts

Category	Description	Part Number
Plug-in modules	MAP-300A GPIB Plug-in Module	MAP-300AGPIB
	MAP-300A Trigger Module	MAP-300ATRIG
	MAP-300 USB-LAN Expansion Module	MAP-300AUSBLAN
Replacement Equipment	MAP-330 Basic Chassis, No Controller	MAP-330CH
	MAP-380 Basic Chassis, No Controller	MAP-380CH
	MAP-380 Reverse Basic Chassis, No Controller	MAP-380RCH
	MAP-300 Modular Controller	MAP-300CLD-B
	Cassette Extraction Latch Kit – Button	MAP-300ACC010
	Cassette Extraction Latch Kit – Legacy	MAP-300ACC011
Optional Touchscreen	15.6-inch Touchscreen	MAP-300AKD
Kits	MAP-330A 3 slot Half 19-in 15.6-in Touchscreen Conversion Kit	MAP-300AKD-B
	Rackmount Conversion Kit, MAP-380	MAP-300ACC01
	Rackmount Conversion Kit, MAP-330	MAP-300ACC02
	Benchtop Conversion Kit	MAP-300ACC03
	Rackmount Kit. 15.6-in Touchscreen	MAP-300ACC04
Protection/Security	Retention Bar for MAP-380 Rackmount and Reverse Rackmount Mainframes	MAP-300ACC05
	Hard Case, MAP-330	MAP-300ACC06
	Hard Case, MAP-380	MAP-300ACC07
	15.6-in Touchscreen Hardcover	MAP-300ACC08
	15.6-in Touchscreen Screen Protector	MAP-300ACC09

Multiple Application Platform, Two-Slot LightDirect Chassis

MAP-220C

The compact, 2U, two-slot MAP-220C LightDirect Chassis mainframe is designed for general fiber-optic lab use and smaller optical manufacturer test-station deployments. The MAP-220C is as efficient and cost-effective as fixed-format versions yet maintains the flexibility and modularity so you can build the application you want, when you want.

As part of the larger MAP Series, the MAP-220C hosts a specific subset of the broader MAP-200 module array focused on light sources, power meters, switches, and attenuators. These basic foundational modules serve as the key building blocks for most test applications. MAP-220C LightDirect Chassis users can leverage these modules in a compact, benchtop format with a simple, intuitive graphical touch screen.

For larger, more complex deployments, VIAVI recommends the three-slot and eight-slot chassis systems. These chassis support all released MAP Series modules.

All MAP Series modules and chassis are completely interoperable with remote interface (GPIB or LXI).

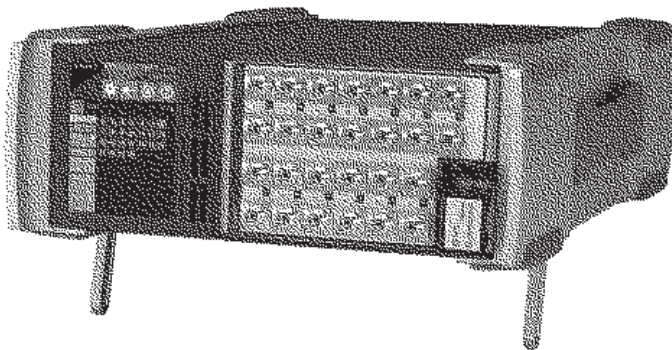

Chassis pictured with mOSW Optical Switch Module installed

Key Features and Benefits

- Compact, two-slot benchtop configuration
- Easily converts to rack-mount configurations in 2 RU high, one-half of a 19-in side-by-side rack format
- LXI-compliant interface with optional GPIB
- Local capacitive touch screen
- Field replaceable controller/power-supply module.

Applications

- General purpose fiber-optic lab use
- Manufacturing test automation
- Light source and optical power meter deployment
- Optical switch and attenuator deployment

Compliance

MAP Series cassettes include amplifier and source cassettes classified as either Class 3B or Class 1M Laser products. While operating in a MAP Series mainframe, cassettes meet the requirements of the IEC 60825-1 standard and comply with 21 CFR 1040.10 and 1040.11, except for deviations pursuant to Laser Notice 50, dated June 24, 2007.

Multiple MAP-220C LightDirect Configurations

The MAP-220C has three main configurations that simplify lab use or manufacturing test station integration.

Benchtop

Because each lab bench is unique, the MAP-220C LightDirect Chassis can be flexibly deployed in the space available. Easily stackable and simple, intuitive flip-up feet for easier positioning. The touch screen display's orientation-sensing ability enables positioning the chassis for use vertically or horizontally.

MAP-220C with installed mOSW Optical Switch module



Rack-Mount and Reverse Rack-Mount

The chassis can be ordered in front- or rear-module entry rack-mount configurations. Rack-mount configurations ship in kits containing all necessary mounting hardware, including kits to mount two units side by side. Because each unit is truly a half 19-inch rack wide, two units can be mounted in one standard test equipment cabinet. Conversion kits are available for mounting benchtop configurations.



Simple, Intuitive Graphical Controller

The MAP-220C LightDirect Chassis supports a bright capacitive touch screen and intuitive page swipes for easier navigation. Critical data is easy to read, simplifying lab work. A PC is not required for basic operation, freeing up critical space and dramatically reducing implementation costs.

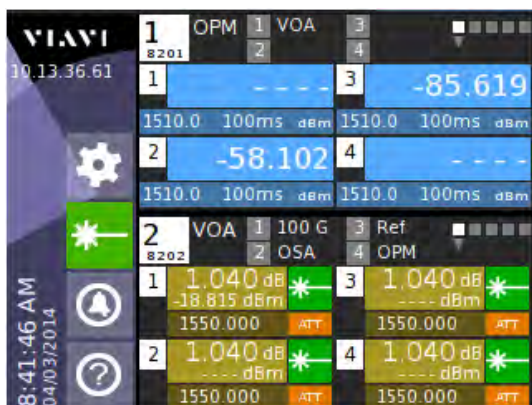
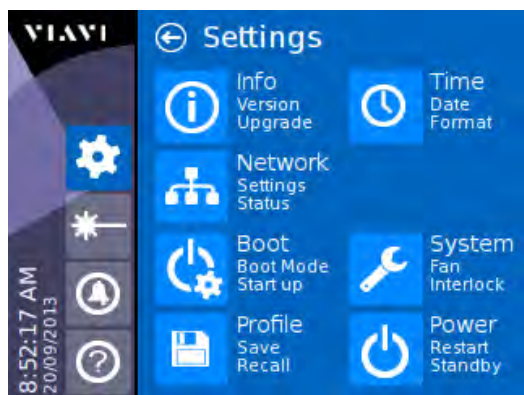

As with all MAP Series platforms, field maintenance is a priority. The power supply/controller unit is field-replaceable. For integrated test systems, this modularity minimizes maintenance down time.

Control Interfaces

As a full-fledged member of the MAP family, all remote interfaces can interoperate with the three-slot and eight-slot versions. For test integration over Ethernet, full LXI certification ensures a simple, standards-based experience. Leveraging Ethernet enables virtual network computing (VNC) and remote log-in to troubleshoot via remote control.

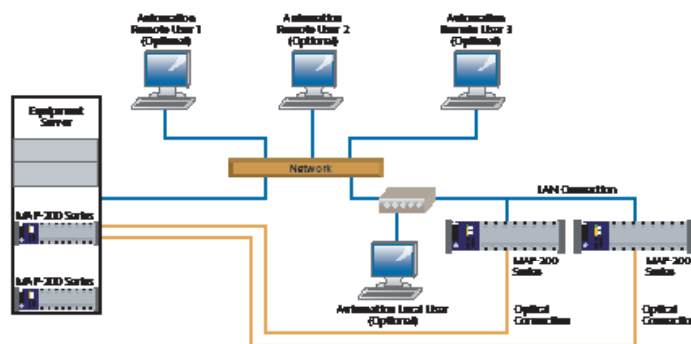

Users who are comfortable with the General Purpose Interface Bus (GPIB) remote interface can order the field-installable option at any time.



Specifications

MAP-220 Parameter	Description
Capacity	2 modules
Controller	
CPU	ARM AM335x
Operating system	Linux
Internal storage	4GB user flash storage
Interfaces	
Remote interface	USB, GPIB (optional), Ethernet 10/100/1000Base-T
USB device capability	Mouse, keyboard, memory stick
Display	Internal display
Ports	
USB host ports	2 rear
LAN	1 rear
GPIB	1 rear (optional)
Automation	
Driver type	IVI-compliant
Driver compatibility	LabVIEW, LabWindows™, Visual C++, Visual Basic
Accessibility	Multi-user sharing support
Electrical and Safety	
Power ¹	100 to 240 V AC, 50/60 Hz, auto-switching (field-replaceable as part of the power supply controller module)
Power consumption	160 VA
Local interlock	Software controlled
Mechanical and Environment²	
Rack-mount kit	Included for MAP-220CX-A or MAP-220CXR-A May be ordered separately to convert a benchtop chassis into a rack-mount chassis.
Dimensions (W x H x D) ³	220 x 88.2 x 387 mm (8.66 x 3.47 x 15.24 in)
Weight	Rack mount: 7 kg (15.43 lb) Benchtop: 8 kg (17.6 lb)
Operating temperature ⁴	0 to 50°C
Storage temperature	-30 to 60°C
Relative humidity ⁵	5 to 85% noncondensing
Display dimensions (H x W)	3.5-inch color screen
Resolution	320 x 240 resolution

Ordering Information

Description	Part Number
MAP-220	
Benchtop, front fiber exit	MAP-220C-A
Rack-mount, front fiber exit	MAP-220CX-A
Rack-mount, rear fiber exit	MAP-220CXR-A
Power Cord (required)	
United States power cord	CORD-US
European power cord	CORD-EU
United Kingdom power cord	CORD-UK
Japan power cord	CORD-JP
Australian power cord	CORD-AU
Accessories (optional)	
GPIB kit	MAP-200CGPIB-A
Rack-mount conversion kit	MAP-200C01
Benchtop conversion kit	MAP-200C02
Replacement/Spare Parts (optional)	
LightDirect controller	MAP-200CLD-A
MAP-200 blanking plates (kit of 3)	MAP-200A06

1. Mains supply voltage fluctuation shall not exceed 10% of nominal supply voltage.
2. The MAP-200 system has been tested and certified to an altitude of 2,000 meters.
3. Dimensions do not include benchtop hardware or rack-mount ears or connector adapters.
4. The MAP-220C, -202C, and -204C chassis are rated for 50°C; however, some MAP-200 supported modules are only rated to 40°C (as specified in the module's user manual). If using one of these modules, the maximum rating temperature will be 40°C.
5. Short term from 0 to 5°C and 40 to 5°C.

MAP Calibration

We are mobilizing our MAP Calibration Service and taking it on the road.

VIAMI has long provided Factory Calibration Services for its MAP modules but now, NEW for VIAMI customers, VIAMI now offers Onsite Calibration. Minimize downtime and maximize reliable utilization of these valuable production assets—VIAMI Onsite Calibration can bring the key aspects of a VIAMI factory calibration directly to you.

No one knows more about these products and how to verify that they are always performing exactly as they should. Trust VIAMI Calibration Services.

We have taken that knowledge and production mentality and intelligently packaged the hardware and processes around field calibration. Our kits comprise a comprehensive and thoughtful toolbox that enable our technician to be effective soon after arriving at your facility.

Thoughtful automation has been intelligently and purposefully built into both the process design and the calibration hardware. The result is that VIAMI is able to get in and out faster, reports and certs are available sooner and you can get back to business.



ONSITE Service is available NOW for the following products:

- MAP ORL
- MAP IL
- MAP SWS
- MAP OCETS
- MAP VOA

Coming Soon:

- MAP OPM
- MAP Sources
- MAP EDFA

For more information, please see the On-Site Services section on page 149.

LightDirect™ Solutions

The LightDirect family includes a wide range of foundational optical test modules that are used in simple bench test applications, or combined in larger, multi-modules customer driven automated test systems. They are easy-to-control, single-functionality modules.

 Light Direct



LightDirect Cassette Families

The VIAVI Multiple Application Platform (MAP) is an optical test and measurement platform optimized for cost-effective development and manufacturing of optical transmission techniques. The MAP chassis are the foundation to our entire portfolio of modules, enabling scalability and efficiency for manufacturing optical network elements. The cassettes are the building blocks and fall into two different families, the LightTest turn-key solutions and the LightDirect configurable solutions to meet each customer's exact needs.



Optical Sources and Amplifiers	Optical Signal Conditioning	Optical Signal Switching and Routing	Optical Power and Spectral Measurements
<p>mTLS-C1 is continuously tunable high-power laser source for general purpose applications across DWDM, optical amplifier and silicon photonic test applications.</p> <p>mTLG-C2 is a distributed feedback (DFB) laser that steps between frequencies of the 50 GHz ITU grid. It is available in either C or L band, and with up to four lasers per module.</p> <p>mSRC-C2 is a general-purpose light source in key fixed telecom wavelengths: 850, 1300, 1310, 1490, 1550, 1625 nm.</p> <p>These sources typically are used to test system load or continuity, measure insertion loss, or for test station calibration.</p> <p>mBBS-C1 is a broadband source that provides an amplified spontaneous emission (ASE) output for stable and spectrally flattened C-and L-band sources.</p> <p>mSRC-C23000SA is a semiconductor O-band optical amplifier (SOA) with polarization-independent optical amplifier.</p>	<p>mVOA-C1 is the industry's most compact modular solution. Available with one, two, or four variable optical attenuators (VOA) per module with or without an internal power meter. The mVOA is the industry's leading variable optical attenuator family, enabling signal-level control for receiver and amplifier testing for over 20 years.</p> <p>mUTL-C1 is a passive utility module that includes, couplers, splitters, mux/demux, band-pass filters and even blank modules for customer supplied components.</p> <p>mPCX-C1 is a polarization scrambler that scrambles, controls and provides stabilization for applications such as temporal depolarization and 100G+ coherent interface testing.</p> <p>mTFX-C1 is a multiport tunable filter that simplifies test signal management for next-generation 100 G+ interface, sub-systems and system test.</p> <p>mVBR-C1 is a variable back reflector with precise levels of return loss to transmitters, enabling measurement of system sensitivity and system degradation as a function of back reflection</p>	<p>mOSW-C1/mISW are the industry's gold standard for loss and repeatability. With over 80 variations available, there is a configuration ideally suited to all applications. Switches range from 1x4 to 1x176 with options for internal power monitoring, direction monitoring, and power trim.</p> <p>mOSX-C1 is a cross connect optical switch that provides high performance and reliability. Available as a 16- or 32-port common connection (CC) cassette, the mOSX supports any-to-any port combinations up to the total number of ports on the cassette. It also supports MxN combinations.</p> <p>mUTL-C1 is a passive utility module that includes, couplers, splitters, mux/demux, band-pass filters and even blank modules for customer supplied components.</p>	<p>mOPM-C1 optical power meters are available with one, two, or four power heads per module with four unique performance ranges. There are versions available for all applications. Models with 110dB dynamic range are complimented by versions that support +27dBm input power.</p> <p>mHROSA-A1 is a high-resolution optical spectrum analyzer that combines sub-GHz resolution performance and compact modularity in a single slot cassette.</p>

Optical Sources and Amplifiers

VIAVI offers optical sources from SLEDs, fixed Fabry-Perot lasers, densely packed step tuned C or L-Band lasers and Broadband noise sources that cover the entire C-band and L-band at high optical powers.

As well as optical sources, VIAVI has several options for optical amplifiers, including low noise and high power EDFAs for system test applications. Options include C and L band versions, plus an O band semiconductor amplifier.



Continuously Tunable Laser Source (mTLS-C1)

MAP Series C- and L-band Continuously Tunable Laser

The MAP Series Tunable Laser Source (mTLS-C1) three-slot cassette offers a long-term reliable, low noise output with a wide tuning range in the C+L band.



The mTLS-C1 is continuously tunable high-power laser source for general purpose applications across DWDM, optical amplifier and silicon photonic test applications. As part of the MAP family, the tunable laser is ideal for use in R&D, NPI and volume manufacturing and is easily integrated into a diverse set of applications alongside the over 15 modules currently offered in the MAP.

Functional Description

The 3-slot module can be housed in the MAP-330 or MAP-380 chassis. In a standalone application, the MAP-330 is ideal and delivers premium performance in one of the smallest footprints on the market. In a MAP-380 there are 5 additional application slots for use with optical switches, power meters, optical spectrum analyzers and a full host of signal conditioning modules.

The laser can be tuned with picometer resolution across the full wavelength range from 1520 nm to 1635 nm. Unlike models that used current tuning to set the output power, precision power control is achieved using an embedded VOA to ensure maximum stability (figure 1) and guarantees low ASE (figure 2) performance across all power and wavelength ranges. 10 dBm output power with PM fiber coupling makes it ideal for waveguide characterization without the need for additional polarization controllers.

Key Benefits

- C+L band continuously tunable source cassettes
- Mod-hop free
- PM-fiber coupled output
- 500 kHz linewidth
- 3-Slot cassette compatible with MAP-300 chassis
- High output power of 10 dBm with low ASE noise floor
- Sweeping and setting operation
- LXI compliant with IVI drivers

Applications

- Optical amplifier testing (Gain and noise figure)
- Channel monitor calibration
- DWDM components testing
- Circuit pack path loss calibration
- Silicon photonic waveguide loss measurements

Safety Information

Complies with 21 CFR 1040.10 and 1040.11 except for deviations pursuant to Laser Notice 50, dated June 24, 2007.

Class 1M Laser Product (IEC 60825-1)

INVISIBLE LASER RADIATION
DO NOT VIEW DIRECTLY WITH
OPTICAL INSTRUMENTS
CLASS 1M PRODUCT
(IEC 60825-1)

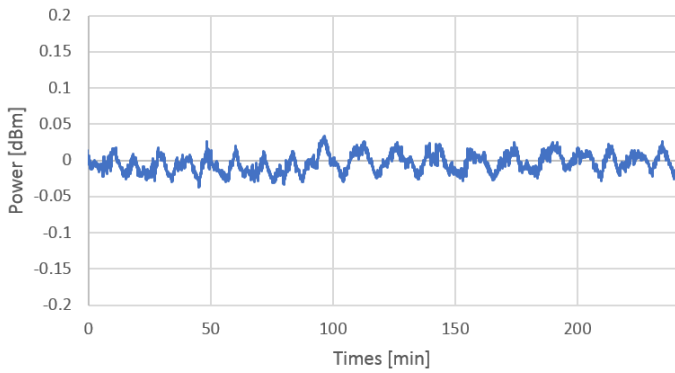

Figure 1: mTLS-C1 Power Stability

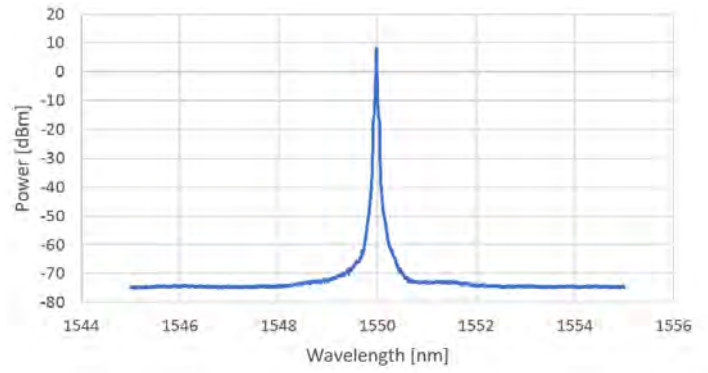

Figure 2: mTLS-C1 Noise Level

Housed in an LXI compliant MAP Series chassis, test automation can be accomplished quickly and efficiently. It is a complimentary module to the high density mTLG-C1 grid tunable laser and is differentiated by its ability to tune continuously across the wavelength range.

An intuitive graphic user interface (GUI) is optimized for use in either a laboratory or a manufacturing environment. Efficient transition between summary widgets

(figure 3) allow users to operate at a system level or access the full power of a module (figure 4).

A full SCPI command line interface is available along with IVI compliant drivers if required.

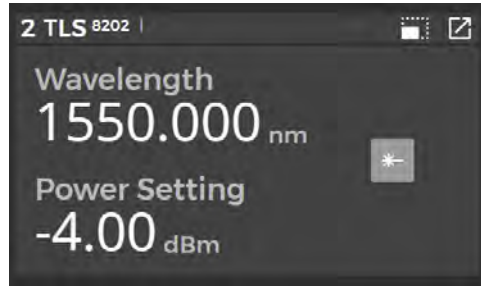

Figure 3: mTLS MAP-300 summary view GUI

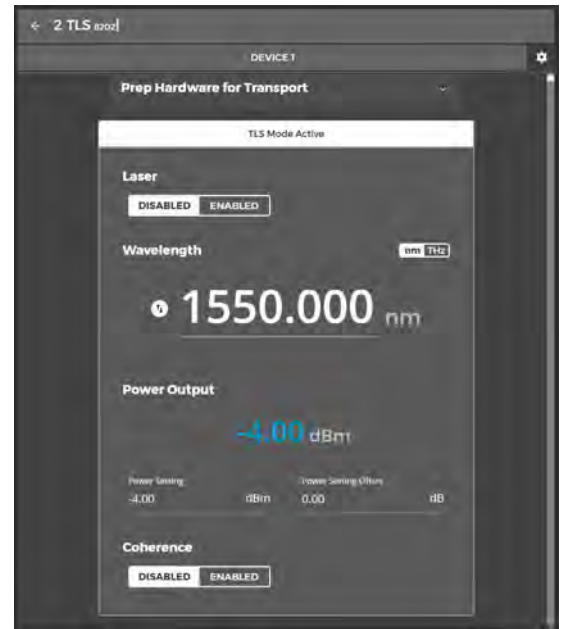

Figure 4: mTLS MAP-300 Detail view GUI

Specifications

For more information on this or other products and their availability, please contact your local VIAVI account manager or VIAVI directly at 1-844-GO-VIAVI (1-844-468-4284) or to reach the VIAVI office nearest you, visit viasolutions.com/contacts.

Parameter	mTLS-C1 Specification
Wavelength	
Tuning range	1520 nm to 1635 nm
Accuracy	± 100 pm
Stability 1 hour ¹	± 5 pm
Wavelength Resolution	1.0 pm
Wavelength Repeatability (Stepped)	± 30 pm
Power	
Maximum output power	10 dBm
Stability 15 minutes	0.01 dB
Stability 1 hour (± 0.5°C)	0.01 dB
Stability 24 hours	0.01 dB
Setting Resolution	0.001 dBm
Spectral properties	
Linewidth	< 1 MHz
SMSR	> 75 dB
RIN ²	< -135 dB/Hz
Power Flatness	
Under Stepping	±0.25dB
Polarization Extinction Ratio³	
	Minimum: > 17 dB
	Typical: > 20 dB
Calibration period	
	1 year
Laser Safety Class	
	1M
Physical / Environment	
Fiber type ⁴	PMF; Polarization aligned to slow axis
Connector type(s)	FC/APC
Warm-up time	< 1 hour
Operating temperature	15°C to 40°C
Operating Humidity	<80% RH, non-condensing
Storage temperature	-35°C to 70°C
Dimensions (W x H x D)	12.2 x 13.0 x 34.8 cm
Weight	6.065 kg
Warranty	3 years

¹± 0.5°C

²0.1 GHz to 2.5 GHz at 1575 nm

³At all powers and wavelengths

⁴Polarization aligned to slow axis and connector

Ordering Information

Available Configurations

Description	Part Number
MTLS-C1CL1-M103-MFA	C- and L-band Continuously Tunable Laser, PMF FC/APC

Tunable DBR Laser (mTLG-C2)

MAP Series Distributed Bragg Reflector Laser

The Multiple Application Platform (MAP series) Tunable Distributed Bragg Reflector (DBR) Laser (mTLG-C2) is a next-generation tunable laser that is ideal for DWDM testing that requires changing the wavelength on demand over the C- and L-band with 50 GHz spacing.



The mTLG-C2 is based on a Sampled Grating Distributed Bragg Reflector (SG-DBR) laser with an integral wavelength locker. Wavelength and output power settings can be controlled using the MAP series local interface or automation interfaces. The integrated wavelocker and automatic power control loop provide stable operation. The mTLG-C2 module is a new generation tunable laser module, which is ideal for DWDM testing where the capability to change wavelength on demand over the C and L

bands with 50GHz spacing is essential.

Functional Description

The mTLG laser modules integrate up to 4 VIAVI Transmit Optical Sub-Assembly TOSA-based Integrable Tunable Laser Assemblies (ITLA) that incorporate an SG-BGR, a Semiconductor Optical Amplifier (SOA), and an integral wavelength locker, all enclosed in a high reliability, hermetically sealed (TOSA) package.

Key Features and Benefits

- Single, dual, or quad channel configurations are available
- C- or L-band tunability
- 42 nm C-band wavelength tuning range (36 nm L-band)
- 50 GHz channel spacing
- Narrow linewidth <5 MHz
- >12 dBm C-band output power (>10.5 dBm L-band)
- SMSR 40 dB min

Applications

- Optical amplifier testing
- Tunable laser grids
- DWDM transmission testing
- Fiber characterization
- Transmitter and receiver testing

Compliance

- The MAP Tunable DBR Laser, when installed in a MAP chassis, complies with CE, CSA/UL/ IEC61010-1, plus LXI class C requirements and meets the standard IEC 60825-1 class 1M requirements

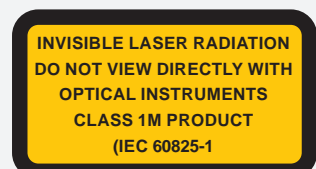

An intuitive graphic user interface (GUI) is optimized for use in either a laboratory or a manufacturing environment. Efficient transition between summary and detailed views (figure 1 and figure 2) allow users to operate at a system level or access the full power of a module.

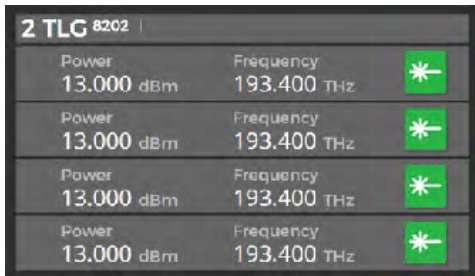

Figure 1 – mTLG MAP-300 summary view GUI

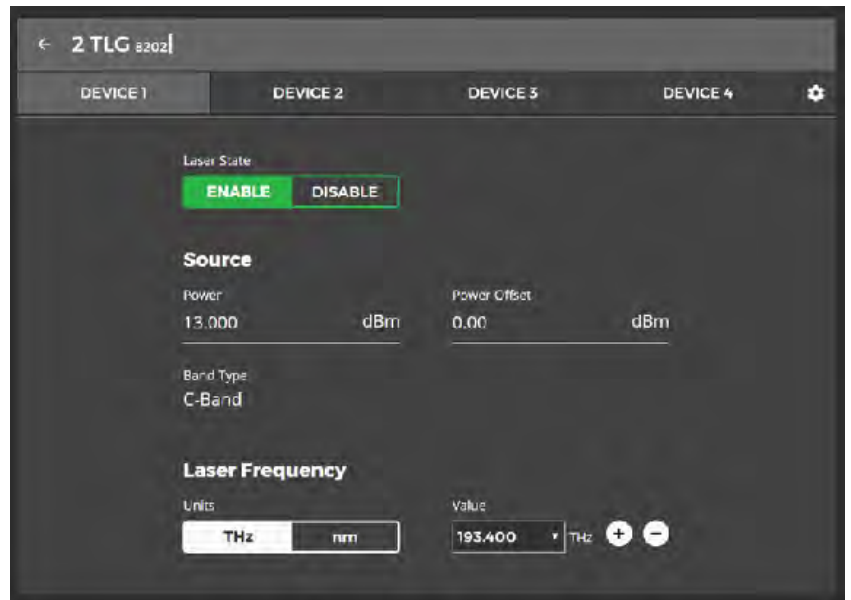

Figure 2 – mTLG MAP-300 detailed view GUI

Options and Configurations

The TLG laser module advances the optical source capability by offering C or L band tunability, and dense configurations with 1, 2 or 4 sources per module.

Specifications

For more information on this or other products and their availability, please contact your local VIAVI account manager or VIAVI directly at 1-844-GO-VIAVI (1-844-468-4284) or to reach the VIAVI office nearest you, visit viasolutions.com/contacts.

Parameters	C-band	L-band
Wavelength		
Tuning range	191.0 to 196.25 THz, 1527.60 to 1569.59 nm	186.35 to 190.90 THz, 1570.42 to 1608.76 nm
Accuracy ^{1,2,3}	±2 GHz (±0.016 nm)	
Stability 15 minutes ^{1,2,3}	±0.005 nm typical	
Stability 24 hours ^{1,2,3}	±0.01 nm typical	
Channel spacing	50 GHz (0.431 nm)	
Power		
Setting range ⁴	7.5 to 13 dBm	7 to 10.5 dBm
Stability 15 minutes ^{1,2,3}	±0.005 dB typical	
Stability 24 hours ^{1,2,3}	±0.03 dB typical	
Resolution	<0.1 dB typical	
Spectral properties		
Linewidth ⁵	≤5 MHz	
RIN	-140 dB/Hz typical; -135 dB/Hz max	
SMSR	40 dB min	
Other		
Fiber type	Polarization maintaining fiber; polarization aligned to slow axis and connector	
Warm-up time ²	1 hour	
Supported connectors	FC/APC	
Humidity	<80% RH, 10 to 40°C noncondensing	
Operating temperature	10 to 40°C	
Dimensions	4.06 x 13.26 x 37.03 (1.6 x 5.22 x 14.58 in)	
Weight	1.3 kg (2.95 lb) maximum (varies with configuration)	
Calibration period	1 Year	

1. At full power

2. After 1-hour warm up

3. Constant temperature within 25 ±3°C

4. Power at max setting: >12 dBm for C-band and >10.5 dBm for L-band

5. Natural (instantaneous) linewidth of the laser; with self-homodyne measurements indicated linewidth is typically

Ordering Information

Part Number	Description
MTLG-C2C10-M100-MFA	Single C-band 50GHz step tunable laser, single mode FC/APC
MTLG-C2C20-M100-MFA	Dual C-band 50GHz step tunable laser, single mode FC/APC
MTLG-C2C40-M100-MFA	Quad C-band 50GHz step tunable laser, single mode FC/APC
MTLG-C2L10-M100-MFA	Single L-band 50GHz step tunable laser, single mode FC/APC
MTLG-C2L20-M100-MFA	Dual L-band 50GHz step tunable laser, single mode FC/APC
MTLG-C2L40-M100-MFA	Quad L-band 50GHz step tunable laser, single mode FC/APC
MTLG-C2C1L1-M100-MFA	Single C-band and L-band 50GHz step tunable laser, single mode FC/APC

© 2020 VIAVI Solutions Inc.
 Product specifications and descriptions in this document are subject to change without notice.
 mtlgc2-ds-lab-nse-ae
 30190909 900 1019

Broadband Light Source (mBBS-C1)

MAP Series 100 mW Amplified Emission Source

The Multiple Application Platform (MAP) Broadband light source (mBBS-C1) delivers 100 mW of amplified spontaneous emission (ASE) across the extended C-band or L-band.

The Multiple Application Platform (MAP) Broadband Source (mBBS-C1) is a third-generation erbium doped fiber-based design. The mBBS module is used for optical component measurement and telecommunications transmission testing:

- Spectral measurements of couplers, WDMs, isolators, and other optical components.
- Noise loading in system experiments.
- Polarization mode dispersion (PMD) measurements.



Functional Description

The mBBS-C1 delivers 100mW of amplified spontaneous emission (ASE) across the extended C-band and the L-band. The optical output of the mBBS is ultra-stable, depolarized and spectrally flat to within 1.8 dB (figures 1a and 1b) and shows power stability better than 0.02dB. These characteristics make it ideal for several applications including noise loading during OSNR compliance test, power loading of optical amplifiers during gain, and noise figure measurements or passive component characterization.

Due to extreme power stability, this source is often used for optical calibration of power meters and variable attenuators.

Features and Benefits

- >100mW depolarized output power over the extended C-band and the L-band
- Power flatness < 1.8dB
- Ultra-high power stability
- LXI-compliant interfaces and IVI drivers

Applications

- Source for optical component spectral tests
- OSNR noise loading for receiver and systems compliance tests
- Power loading for optical amplifier testing
- Ultra-stable source for optical calibration systems

Compliance and Safety information

- The MAP Series mBBS-C1 module, when installed in a MAP chassis, complies to CE, CSA/UL/IEC61010-1, LXI Class C requirements, meets the requirements of Class 1M in standard IEC 60825-1 (2014), and complies with 21 CFR 1040.1 except deviations per Laser Notice No. 50, June 24, 2007



The optics of the mBBS Module consist of an erbium-based gain block with supporting optical components specifically designed to achieve maximum output power at the bulkhead-mounted optical connector while minimizing input/output isolation.

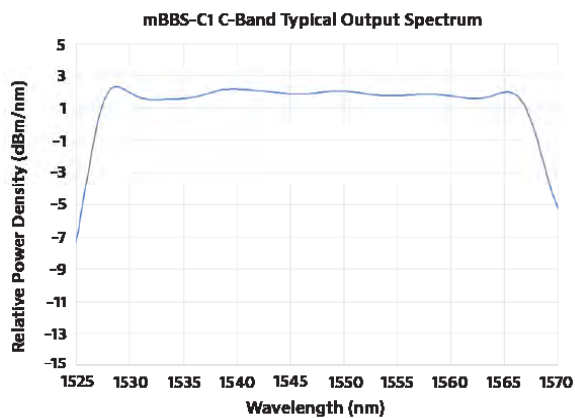

Figure 1b – C-band output spectrum

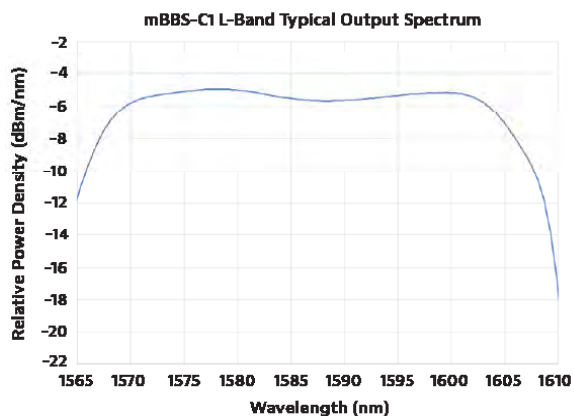

Figure 1b – L-band output spectrum

An intuitive graphic user interface (GUI) is optimized for use in either a laboratory or a manufacturing environment. Efficient transition between summary and detailed views (figure 2) allow users to operate at a system level or access the full power of a module.

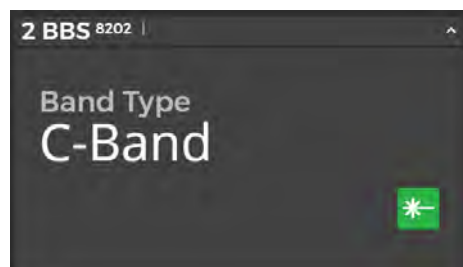

Figure 2 - mBBS MAP-300 summary view GUI

Specifications

Parameter ¹	C-Band	L-Band
Operating Wavelength Range	1525nm – 1568nm	1565 – 1610nm
Saturated Power ²	≥ 20dBm	
Spectral Gain Flatness · C-band spectral range: 1529-1565nm · L-band spectral range: 1570-1603nm	≤ 1.8dB	
Total Power Stability ³	≤ 0.02dB	
Laser Safety Class ⁴	1M	
Fiber Type ⁵	Single Mode Fiber	
Connector Type	FC/APC	
Operation Temperature	0 – 40°C	
Operation Humidity	Maximum 95% RH, 0 to 40°C non condensing	
Storage Temperature	-30 to 60°C	
Dimensions (W x H x D)	4.06cm x 13.26cm x 37.03cm	
Weight	2.3kg	

1. All optical measurements were done after minimum 30 minutes warming up measured at constant temperature of 23±3°C

2. Measured with OPM set at wavelength of 1550nm for C-band; 1590nm for L-band

3. Measured as peak to peak variation within 30 minutes

4. Classified as per standard IEC60825-1:2014

5. For IEC60793-2-50 Type B1.3/ ISO 11801 OS2 compliant fiber, i.e. Corning SMF-28e

Ordering Information

For more information on this or other products and their availability, please contact your local VIAVI account manager or VIAVI directly at 1-844-GO-VIAVI (1-844-468-4284) or to reach the VIAVI office nearest you, visit viasolutions.com/contacts.

Part Number	
MBBS-C11CA-M100-MFA	Broadband source, Extended C-band, Flattened with FC/APC connectors
MBBS-C11LA-M100-MFA	Broadband source, L-band, Flattened with FC/APC connectors

Erbium Doped Fiber Amplifier (mEDFA-C1)

An Amplifier Design Optimized for Use in the Systems-Lab or for Optical Test for MAP Series

The Multiple Application Platform (MAP) Erbium Doped Fiber Amplifier (mEDFA-C1) is a third-generation amplifier design, optimized for use in the systems-lab or for optical test and measurement applications. The simplified control and modular design make the module extremely simple to integrate and use, removing the need to “work-around” networking management protocols that often frustrate the R&D and manufacturing engineers and slow down test automation.



MAP Erbium-Doped Fiber Amplifier (mEDFA) Modules combine the optical performance of the traditional VIAVI benchtop models with the flexibility and modularity of the MAP series. The variants of the EDFA target diverse applications such as amplifier emulation, OSNR (optical signal-to-noise ratio) experiments, and network compliance tests.

While simple to control from the front panel or over the remote interface, mEDFA-C1 amplifiers meet some of the most demanding optical specifications including a low noise version with <math><3.7\text{dB}</math> noise

figure. These low noise amplifiers are essential for test automation implementations where system path loss requires a test signal power boost prior to application to the DUT. In most cases OSNR impairments must be kept to a minimum. Auto gain and power control options are designed to simplify power management, in particular when a single channel tunable source is used. DWDM, High Power and an L-band version are also available.

Features and Benefits

- Variant options to cover low noise figure (<math><3.7\text{dB}</math>) or high power (>25dBm) requirements
- Single-channel Extended C and L band versions
- Gain flattened DWDM multichannel extended C band versions
- Automated gain and power control options

Applications

- Amplification of sensitive signals in automated test systems
- Power saturation recovery testing
- OSNR noise loading

Compliance

- The MAP-200 mEDFA-C1 module, when installed in a MAP chassis, complies to CE, CSA/UL/IEC61010-1, LXI Class C requirements, meets the requirements of Class 3B in standard IEC 60825-1 (2014), and complies with 21 CFR 1040.1 except deviations per Laser Notice No. 50, July 2001

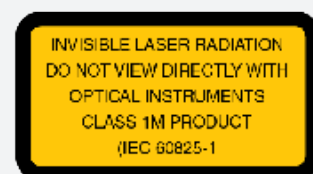

Functional Description

The optics of the MAP series EDFA module consists of an erbium-doped fiber amplifier (EDFA) gain stage with supporting optical components specifically designed to achieve maximum output power at the bulkhead mounted optical connector while maximizing input/output isolation. An optical fiber doped with the rare-earth erbium can be made to amplify light signals passing through it by exciting the erbium atoms.

GUI and Remote Interfaces

The MAP series is the first photonic layer lab and manufacturing platform that complies with LAN Extensions for Instrumentation (LXI) by conforming to the required physical attributes, Ethernet connectivity, and interchangeable virtual instrument (IVI) drivers, which are intuitive and optimized for ease of use with popular Application Development Environments such as LabVIEW, Visual C++, Visual Basic, and LabWindows™. The optimized MAP platform's industry-leading density and maximum configurability meets specific application requirements within the smallest footprint. All MAP series modules and platforms commands generally conform to the Standard Commands for Programmable Instruments (SCPI) command language.

The MAP-300 chassis GUIs are easily accessed through Google Chrome, Mozilla Firefox and Microsoft Edge web browsers or a remote VNC. As shown in figure 1, the MAP-300 GUI for the mEDFA allows the change of current mode set point for multiple devices, while also giving control of the pump laser state. For legacy MAP-200 users the GUI is still accessible through remote VNC.



mEDFA MAP-300 GUI

Options and Configurations

The mEDFA-C1 has six carefully selected variants designed to span the most critical application requirements.

Version	Amplifier per module	Input Type	Band	Gain and Power Control	Saturated Output Power	Application
MEDFA-C11CA Preamp	1	Single Channel	C	No	Standard	Preamp. Minimize noise figure while providing enough gain to ensure test signal at required power
MEDFA-C12CA Dual Preamp	2	Single Channel	C	No	Standard	Dual CA version amplifiers. Improves test system density for applications requiring more than one.
MEDFA-C11CB Booster	1	Single Channel	C	Yes	Standard	Booster. Adding gain and power control simplifies power level control but increases noise figure slightly. Ideal for single channel tunable signal applications.
MEDFA-C11CF DWDM Booster	1	DWDM	C	Yes	Standard	DWDM Booster. For full multichannel input applications. Power and gain control available.
MEDFA-C11CD Max Power	1	Single Channel	C	Yes	High	Maximum power. Amplifier optimized to deliver the maximum allowable saturated output power for standard lab safety protocols. Ideal for signal splitting or power saturated recover testing.
MEDFA-C11LB L-Band Booster	1	Single Channel	L	Yes	Standard	L-band version of the Booster amplifier.

Specifications

For more information on this or other products and their availability, please contact your local VIAVI account manager or VIAVI directly at 1-844-GO-VIAVI (1-844-468-4284) or to reach the VIAVI office nearest you, visit viavisolutions.com/contacts.

Single Channel Input Optical Specifications ¹		mEDFA-C11CA mEDFA-C12CA	mEDFA-C11CB	mEDFA-C11LB
Operating Wavelength Range		1528 nm – 1569 nm		1565 nm – 1610 nm
Saturated Power ²		≥ 20 dBm (-4 dBm input)		
Noise Figure ³	P _{in} = 0 dBm	N/A	N/A	≤ 5.7 dB
	P _{in} = -4 dBm	≤ 4.4 dB	≤ 4.5 dB	≤ 5.5 dB
	P _{in} = -20 dBm	≤ 4.1 dB	≤ 5.3 dB	≤ 5.2 dB
	P _{in} = -30 dBm	≤ 3.7 dB	≤ 5.5 dB	N/A
Gain ₃	P _{in} = 0 dBm	N/A	N/A	≥ 20 dB
	P _{in} = -4 dBm	≥ 24 dB	≥ 24 dB	≥ 23 dB
	P _{in} = -20 dBm	≥ 35 dB	≥ 33 dB	≥ 28 dB
	P _{in} = -30 dBm	≥ 37 dB	≥ 36 dB	N/A
Input Output Power Monitor		No	Yes	Yes
PDL/PDG ⁴		≤ 0.2dB	≤ 0.2dB	≤ 0.2dB
Laser Safety Class ⁵		1M		

¹All optical measurements were done after minimum 30 minutes warming up measured at constant temperature of 23±3°C

²Saturated power was measured with input signal at 1550nm for C-band and 1590nm for L-band

³Measured at wavelength of 1550nm for C-band and 1590nm for L-band

⁴Measured with input power of -4dBm at 1550nm for C-band and 0dBm at 1590nm for L-band

⁵Classified as per standard IEC60825-1:2014 with the maximum input power +4dBm

DWDM Multichannel Input Optical Specifications ¹		mEDFA-C11CF
Operating Wavelength Range		1528 nm – 1569 nm
Saturated Power ²		≥ 21 dBm (-4 dBm input)
Noise Figure ²	P _{in} = -4 dBm	≤ 5.5 dB
	P _{in} = -20 dBm	≤ 5.2 dB
Gain ³	P _{in} = -4 dBm	≥ 25 dB
	P _{in} = -20 dBm	≥ 35 dB
Input Output Power Monitor		Yes
Spectral Gain Flatness ³		≤ 2.0 dB
PDL/PDG ⁴		≤ 0.2 dB
Laser Safety Class ⁵		1M

¹All optical measurements were done after minimum 30 minutes warming up measured at constant temperature of 23±3°C

²Measured at wavelength of 1550nm

³Measured with input power of -4dBm for the wavelength range of 1528nm –1563nm

⁴Measured at wavelength of 1550nm, -4dBm input power

⁵Classified as per standard IEC60825-1:2014 with the maximum input power +4dBm

High Power Single Channel Input Optical Specifications ¹		mEDFA-C11CD
Operating Wavelength Range		1528 nm – 1569 nm
Saturated Power ²		≥ 25 dBm (-4 dBm input)
Noise Figure ²	P _{in} = -4 dBm	≤ 5.5 dB
	P _{in} = -20 dBm	≤ 5.2 dB
Gain ²	P _{in} = -4 dBm	≥ 25 dB
	P _{in} = -20 dBm	≥ 35 dB
Input Output Power Monitor		Yes
PDL/PDG ³		≤ 0.2 dB
Laser Safety Class ⁴		3B

¹All optical measurements were done after minimum 30 minutes warming up measured at constant temperature of 23±3°C

²Measured at wavelength of 1550nm

³Measured with input power of -4dBm at 1550nm

⁴Classified as per standard IEC60825-1:2014

Common Specifications	
Connector Type	FC/APC
Operating Temperature	0 - 40°C
Operating Humidity	Maximum 95% RH, 0 to 40°C noncondensing
Storage Temperature	-30 to 60°C
Dimensions (W x H x D)	4.06 cm x 13.26 cm x 37.03 cm
Weight	2.3 kg

Ordering Information

Part Number	
MEDFA-C11CA-M100-MFA	Standard power, Extended C-band amplifier, Low NF Single channel with FC/APC connectors
MEDFA-C12CA-M100-MFA	Dual independent, Standard power, Extended C-band amplifier, Low NF Single channel with FC/APC connectors
MEDFA-C11CB-M100-MFA	Standard power, Extended C-band amplifier, Single channel auto power and monitoring option with FC/APC connectors
MEDFA-C11CF-M100-MFA	Standard power, Extended C-band amplifier DWDM Gain Flattened Auto power and monitoring option with FC/APC connectors
MEDFA-C11CD-M100-MFA	High power, Extended C-band amplifier Single channel with Auto power and monitoring option with FC/APC
MEDFA-C11LB-M100-MFA	Standard power, Extended L-band amplifier, Single channel auto power and monitoring option with FC/APC connectors

© 2020 VIAVI Solutions Inc.
Product specifications and descriptions in this document are subject to change without notice.
medfa-c1-ds-lab-nse-ae
30190976 900 1119

Distributed Feedback (DFB) Source Module

Part of the MAP Series General Purpose mSRC-C2 family

The Multiple Application Platform (MAP) Distributed Feedback (DFB) lasers are stabilized fixed wavelength light sources with coverage of O-, C- and L-band telemetry wavelengths at 1310, 1510, 1610, 1625 and 1653 nm.



VIAVI offers a range of DFB lasers as part of the general purpose light source modules (mSRC) in the MAP portfolio. DFB lasers are offered at the standard O, C and L-band telemetry wavelengths, plus the common out-of-band OTDR sensing wavelengths at 1625 and 1653nm.

DFB lasers are narrow-linewidth lasers that use a grating to define the output wavelength very precisely. They also offer good side-band suppression and are inherently mode-hop free. They are typically used for applications where wavelength and power stability are key.

Functional Description

DFB lasers are similar to Fabry-Perot cavity, but with grating above active layer. The main advantage of a distributed feedback (DFB) laser is to sharpen up the output of regular Fabry-Perot lasers.

VIAVI DFB laser modules have excellent output power stability ($\pm 0.025\text{dB}$), figure 1. Optical isolators eliminate stability effects caused by back reflection from dirty or open connectors.

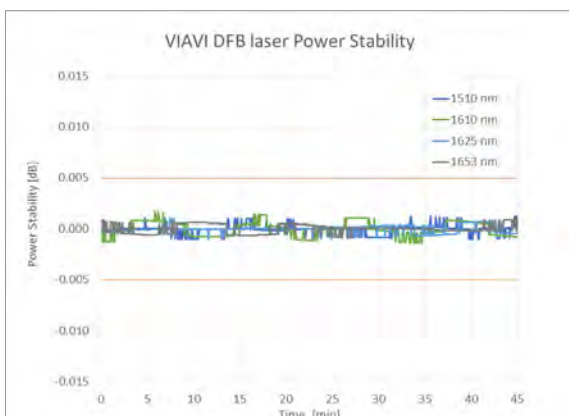

Figure 1 -DFB Source Stability over three hours at constant current mode and at room temperature

Key Features

- One, two or four individual outputs
- Single Mode variant
- Compatible with all MAP-300 series and MAP-220

Applications

- 1310nm source enables R&D tests in Silicon-Photonic applications
- Channel monitoring in DWDM systems
- DFB sources for system telemetry channels
- Loss and power meter calibration
- Enabling 400GE manufacturing test.
- Spectroscopy, metrology and atomic physics
- Wavelength grid matched to LANWDM channels with power adjustment of at least 10dB

Compliance

- The MAP series mSRC-C2 module, when installed in a MAP chassis, complies to CE, CSA/ UL/IEC61010-1, LXI Class C requirements, meets the requirements of Class 1M in standard IEC 60825-1 (2014), and complies with 21 CFR 1040.1 except deviations per Laser Notice No. 50.

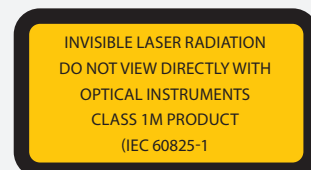

An intuitive graphic user interface (GUI) is optimized for use in either a laboratory or a manufacturing environment. Efficient transition between summary and detailed views allows users to operate at a system level or access the full power of a module.

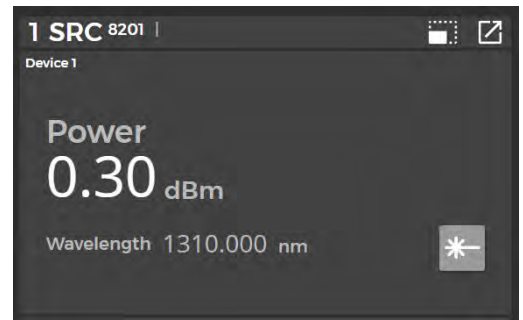

Figure 2 – mSRC-C2 MAP-300 summary view GUI

Options and Configurations

The VIAVI DFB sources are offered in multiple individual output cassette or a single output.

Source	Target Applications
1310	Generalized O-band source
1510	C-band telemetry
1610	L-band telemetry
1625	OTDR sensing channel
1653	Out-of-band OTDR sensing channel

Specifications

For more information on this or other products and their availability, please contact your local VIAVI account manager or VIAVI directly at 1-844-GO-VIAVI (1-844-468-4284) or to reach the VIAVI office nearest you, visit viavisolutions.com/contacts.

Optical Parameters ¹	Single Mode DFB Source						
Peak Wavelength ²	1310nm	1510nm	1610nm	1625nm	1653nm	1310/1510nm	1510/1610/1625/1653nm
Spectral Width (FWHM)	<0.03nm						
Output Optical Power	≥ 6dBm						
Optical Power Stability (15 minutes) ³	±0.005 dB						
Optical Power Stability (3 hours) ³	±0.025 dB						
TEC Stabilized	Yes						
Wavelength Tolerance	±3nm						
Optical Power Turning Range ⁴	≥ 10dB						
Power Control Mode	Constant Current or Constant Power						
Modulation ⁵	0.15 to 2kHz						
Modulation Setting Resolution	1Hz						
Modulation Accuracy	±0.5Hz						
Fiber Type ⁶	Singlemode Fiber						
Connector Type	FC/APC						

1. All optical measurements were done after minimum 30 minutes warming up
2. Center wavelength was defined as per IEC 61280-1-3 2010 clause 8.2.
3. Measured at constant temperature of 23±5°C, at full power.

4. From maximum power down
5. Modulation duty cycle is fixed at 50%. Modulation depth is fixed at 100%
6. For IEC 60793-2-50 Type B1.3/ ISO 11801 OS2 compliant fiber, i.e. Corning SMF-28e

General Specifications

Parameter	Specification
Operating Temperature	10 to 40 °C (50 to 104 °F)
Storage Temperature	-30 to 60 °C (-22 to 140 °F)
Operating Humidity	Maximum 85% Relative Humidity, non-condensing from 10 to 40 °C/50 to 104 °F
Dimensions (W x H x D)	4.06 x 13.26 x 37.03 cm (1.6 x 5.22 x 14.58 in)
Weight	1.3 kg (2.86 lb)
Warranty	3 years

Ordering Information

Part Number	DFB Single Mode Source	
MSRC-C23000DF-M100-MFA	Single Output	1310nm DFB TEC laser SMF FC/APC Connectors
MSRC-C2C000DF-M100-MFA		1510nm DFB TEC laser SMF FC/APC Connectors
MSRC-C2D000DF-M100-MFA		1610nm DFB TEC laser SMF FC/APC Connectors
MSRC-C26000DF-M100-MFA		1625nm DFB TEC laser SMF FC/APC Connectors
MSRC-C2E000DF-M100-MFA		1653nm DFB TEC laser SMF FC/APC Connectors
MSRC-C23C00DF-M100-MFA	Multiple Individual Outputs	1310/1510nm DFB TEC laser SMF FC/APC Connectors
MSRC-C2CD6EDF-M100-MFA		1510/1610/1625/1653nm DFB TEC laser SMF FC/APC Connectors

© 2020 VIAVI Solutions Inc.
 Product specifications and descriptions in this document are subject to change without notice.
 dfbmodule-ds-lab-nse-ae
 30192816 900 0920

Fabry Perot (FP) Source Module

Part of the MAP Series General Purpose mSRC-C2 family

Multiple Application Platform (MAP) modules with Fabry-Perot (FP) lasers, are stabilized, high power, fixed wavelength light sources at the key telecom wavelengths 850, 1300, 1310, 1490, 1550 and 1625 nm.



VIAMI offers a wide range of FP lasers as part of the general purpose light source (mSRC) module in the MAP portfolio. The FP lasers are offered at the standard singlemode wavelengths of 1310nm, 1490nm, 1550nm and 1625nm. Multimode versions are offered at 850 and 1300nm.

Functional Description

VIAMI Fabry Perot (FP) Lasers emit light at commonly used discrete wavelengths. They have spectral width in the region of 5 nm, and a high output power level. Cooled

FP lasers are ideal sources for general loss measurements of broadband optical components.

VIAMI FP lasers have a stable output power (figure 1) with the cooled versions having a stability of $\pm 0.005\text{dB}$. External isolators in the module ensure stability in the presence of reflections from open PC or dirty connectors.

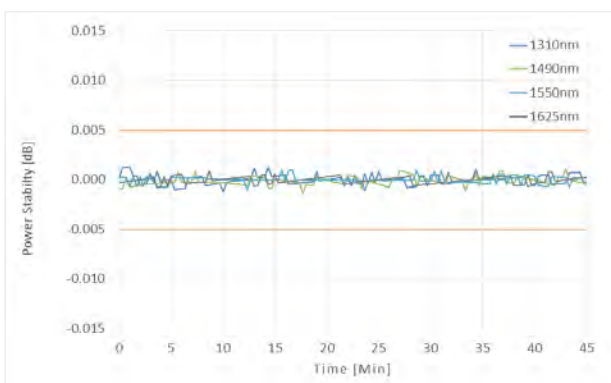

Figure 1 -mSRC-C2 FP Laser Power Stability

Key Features

- Basic or TEC'd FP laser.
- Single Mode and Multimode versions.
- Simplify test system integration with individual output connectors per wavelength or pre-multiplexed.

Applications

- Insertion loss testing.
- General power meter or loss calibration.
- Applications requiring modulation from 150 to 2000 Hz with 1Hz resolution.
- Transient loss testing stimulus.
- Multimode loss testing with IEC compliant launch conditions

Compliance

- The MAP series mSRC-C2 module, when installed in a MAP chassis, complies to CE, CSA/ UL/IEC61010-1, LXI Class C requirements, meets the requirements of Class 1M in standard IEC 60825-1 (2014), and complies with 21 CFR 1040.1 except deviations per Laser Notice No. 50,

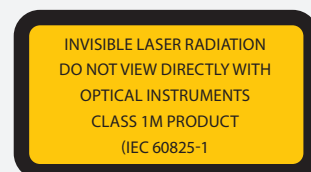

An intuitive graphic user interface (GUI) is optimized for use in either a laboratory or a manufacturing environment. Efficient transition between summary and detailed views allows users to operate at a system level or access the full power of a module.

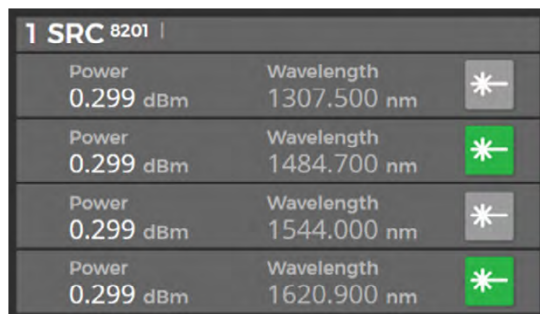

Figure 2 – mSRC-C2 MAP-300 summary view GUI

Options and Configurations

The VIAVI FP sources are offered in non-TEC'd and TEC variant.

FP Variant	Available Configurations
Single Mode Basic FP	1310/1550nm individual output
	1310/1550nm multiplexed output
Single Mode TEC'd FP	1310/1550nm individual output
	1310/1490/1550/1625nm individual output
	1310/1550nm multiplexed output
	1310/1490/1550/1625nm multiplexed output
Multimode Basic FP	850/1300nm individual output
	850/1300nm multiplexed output

Specifications

For more information on this or other products and their availability, please contact your local VIAVI account manager or VIAVI directly at 1-844-GO-VIAVI (1-844-468-4284) or to reach the VIAVI office nearest you, visit viavisolutions.com/contacts.

Optical Parameters ¹	Single Mode Basic FP Sources			Single Mode TEC'd FP Sources					
	1310 nm	1550 nm	1310 / 1550 nm mux	1310 nm	1490 nm	1550 nm	1625 nm	1310/1550 nm mux ³	1310/1490/1550/1625 nm mux ³
Peak Wavelength ²	1310 nm	1550 nm	1310 / 1550 nm mux	1310 nm	1490 nm	1550 nm	1625 nm	1310/1550 nm mux ³	1310/1490/1550/1625 nm mux ³
Spectral Width (FWHM)	< 5 nm	As per individual specifications		< 5 nm				As per individual specifications	
Output Optical Power ^{4, 5}	≥ 0 dbm	≥ -4 dbm		0 dbm				≥ -4 dbm	≥ -8 dbm
Optical Power Stability for 15 min ³	±0.1 dB	±0.15 dB		±0.005 dB				±0.01 dB	
Optical Power Stability for 3 hours ³				±0.005 dB				±0.01 dB	
TEC Stabilized	No			Yes					
Wavelength Tolerance	±20 nm								
Optical Power Tuning Range ⁵	≥ 10 dB								
Power Control Mode	Constant Current or Constant Power								
Modulation ⁷	0.15 to 2.0 kHz								
Modulation Accuracy	±0.5 Hz								
Fiber Type ⁸	Single Mode Fiber								
Connector Type	FC/APC								

1. All optical measurements after minimum 30 minutes warm-up

2. Peak wavelength defined as per IEC 61280-1-3 2010 clause 3.1.3. Measured at 23°C

3. Combined output power. Power measured with any 1 laser on full power at a time

4. Measured at full power at controlled environment of $\Delta T = \pm 1^\circ$, constant current mode with APC connector (SM) direct to power meter

5. Guarantee of 0dBm excluding connector losses for non-mux version

6. From maximum power down

7. Modulation duty cycle is fixed at 50%. Modulation depth is fixed at 100%

8. For IEC 60793-2-50 Type B1.3/ ISO 11801 OS2 compliant single mode fiber, or IEC 60793-2-10, Type A1a MM / ISO 11801 OM2 compliant multi mode fiber

Specifications continued

Optical Parameters ¹	Multimode FP Sources		
Peak Wavelength ²	850 nm	1310nm	850/1310 nm Muxed ³
Spectral Width (FWHM)	< 5 nm		
Optical Launch Conditions	IEC 62614 Ed 1.0 July 2010		
Output Optical Power ⁴	≥ -6.5 dBm	≥ -3.5 dBm	≥ -11dBm (850nm) ≥ -8 dBm (1310nm)
Optical Power Stability for 15 min ⁴	±0.20 dB		±0.30 dB
TEC Stabilized	No		
Wavelength Tolerance	±20 nm		
Optical Power Tuning Range ⁴	Fixed Output Power		
Power Control Mode	Constant Current		
Modulation ⁵	0.15 to 2.0 kHz		
Modulation Setting Resolution	1 Hz		
Modulation Accuracy	±0.5 Hz		
Fiber Type ⁶	Multimode Fiber		
Connector Type	FC/PC		

1. All measurements after a minimum of 30 minutes warm-up time.

2. Peak wavelength defined as per IEC 61280-1-3 2010 clause 3.1.3. Measured at room temperature.

3. Combined output power. Power measured with any one laser on full power at a time.

4. Measured at full power at controlled environment of $\Delta T = \pm 1^\circ$, constant current mode direct to power meter

5. Modulation duty cycle is fixed at 50%. Modulation depth is fixed at 100%

6. For IEC 60793-2-50 Type B1.3/ ISO 11801 OS2 compliant single mode fiber, or IEC 60793-2-10, Type A1a MM / ISO 11801 OM2 compliant multi mode fiber

General Specifications

Parameter	Specification
Operating Temperature	10 to 40 °C (50 to 104 °F)
Storage Temperature	-30 to 60 °C (-22 to 140 °F)
Operating Humidity	Maximum 85% Relative Humidity, non-condensing from 10 to 40 °C/50 to 104 °F
Dimensions (W x H x D)	4.06 x 13.26 x 37.03 cm (1.6 x 5.22 x 14.58 in)
Weight	1.3 kg (2.86 lb)
Warranty	3 years

Ordering Information

Part Number	FP Single Mode Source		
MSRC-C23500FB-M100-MFA	Basic FP Laser	Individual Output	1310/1550nm Basic FP laser SMF FC/APC Connectors
MSRC-C23500FBX-M100-MFA		Single Output (Mux'd)	1310/1550nm Basic FP Laser Single output SMF FC/APC connectors
MSRC-C23500FP-M100-MFA	TEC'd FP Laser	Individual Output	1310/1550nm Standard FP laser SMF FC/APC Connectors
MSRC-C23456FP-M100-MFA			1310/1490/1550/1625nm Standard FP laser SMF FC/APC Connectors
MSRC-C23500FPX-M100-MFA		Single Output (Mux'd)	1310/1550nm Standard FP laser SMF Single output FC/APC Connectors
MSRC-C23456FPX-M100-MFA			1310/1490/1550/1625nm Standard FP laser SMF Single output FC/APC Connectors

Part Number	50µm (OM3) Multimode Sources		
MSRC-C21308FP-M101-MFP	Basic FP laser	Individual Output	850/1310nm Standard FP Laser 50um MMF EF compliant FC/PC Connectors
MSRC-C21308FPX-M101-MFP		Single Output (Mux'd)	850/1310nm Standard FP Laser Single output 50um MMF EF compliant FC/PC Connectors

Light Emitting Diode (LED) Source Module

Part of the MAP Series General Purpose mSRC-C2 family

Multiple Application Platform (MAP) broadband light sources featuring Light Emitting Diode laser (LED) are stabilized, low power, fixed wavelength modules, with output wavelengths at the two most commonly used multimode wavelengths – 850nm and 1300nm.



VIAMI offers a multiplexed and individual output low power LED as part of the general-purpose light sources (mSRC) in the MAP portfolio. The LEDs are offered at the common multimode wavelengths of 850nm and 1300nm. LED sources emit incoherent broadband light.

Functional Description

LED sources are used for testing of broadband multimode components. They have a slightly broader spectral width and lower output power than SLEDs and Fabry-

Perot (FP) lasers. The incoherent nature of LED light sources avoids interference in short fibers with reflection present.

Mode fill is key for accurate measurement of multimode components and systems. An under or over-filled launch can give optimistic or pessimistic loss results that don't reflect the actual loss of a component or system. VIAMI low power LED sources have ± 0.05 dB power stability and a fixed power level.

Key Features

- MM Individual Output or Multiplexed Output.
- Low temperature dependence
- ± 0.05 dB optical power stability
- Fixed optical power

Applications

- Multimode loss testing with IEC compliant launch conditions
- Loss calibration
- Ideal source to calibrate optical receivers due to low temperature dependence and excellent stability

Compliance

- The MAP series mSRC-C2 module, when installed in a MAP chassis, complies to CE, CSA/ UL/IEC61010-1, LXI Class C requirements, meets the requirements of Class 1M in standard IEC 60825-1 (2014), and complies with 21 CFR 1040.1 except deviations per Laser Notice No. 50

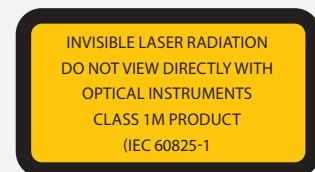

An intuitive graphic user interface (GUI) is optimized for use in either a laboratory or a manufacturing environment. Efficient transition between summary and detailed views allows users to operate at a system level or access the full power of a module.

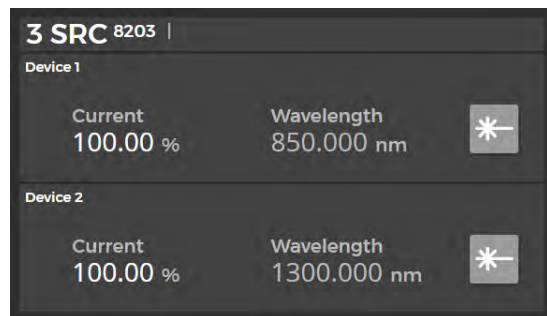

Figure 1– mSRC-C2 MAP-300 summary view GUI

Options and Configurations

The VIAVI LED sources are offered in two variants with individual outputs or multiplexed outputs.

LED variant	Available Configurations
Individual Output	Individual 850/1300 nm output
Mux'd Output	Multiplexed 850/1300 nm output

Specifications

For more information on this or other products and their availability, please contact your local VIAVI account manager or VIAVI directly at 1-844-GO-VIAVI (1-844-468-4284) or to reach the VIAVI office nearest you, visit viavisolutions.com/contacts.

Optical Parameter ¹	Standard MM Low Power LED		
Peak Wavelength ²	850 nm	1300 nm	850/1300 nm Mux'd ³
Wavelength Tolerance	±20 nm		
Spectral Width (FWHM)	>40 nm		
Spectral Ripple (RB=0.1 nm)	-		
Output Optical Power ⁴	≥ -20 dBm		≥ -25dBm
Optical Power Stability (15 minutes) ⁴	±0.05 dB		
Optical Power Tuning Range	Fixed Output Power		
Output Launch Conditions	IEC 62614 Ed 1.0 July 2010		
Modulation ⁵	0.15 to 2kHz		
Modulation Setting Resolution	1Hz		
Modulation Accuracy	±0.5Hz		
Fiber Type	OM3 MM fiber		

1. All measurements taken after a minimum of 30 minutes warm-up time.

2. Peak wavelength defined as per IEC 61280-1-3 2010 clause 3.1.3. Measured at room temperature.

3. Combined output power. Power measured with any one laser on full power at a time.

4. Measured at full power at controlled environment of $\Delta T = \pm 1$ °C, Constant Current mode with PC connector (MM) direct to power meter.

5. Modulation duty cycle is fixed at 50%. Modulation depth is fixed at 100%.

General Specifications

Parameter	Specification
Operating Temperature	10 to 40 °C (50 to 104 °F)
Storage Temperature	-30 to 60 °C (-22 to 140 °F)
Operating Humidity	Maximum 85% Relative Humidity, non-condensing from 10 to 40 °C/50 to 104 °F
Dimensions (W x H x D)	4.06 x 13.26 x 37.03 cm (1.6 x 5.22 x 14.58 in)
Weight	1.3 kg (2.86 lb)
Warranty	3 years

Ordering Information

Part Number	LED Single Mode Source	
MSRC-C21308LP-M101-MFP	Individual Output	850/1300nm Low power LED 50µm MMF EF compliant FC/PC
MSRC-C21308LPX-M101-MFP	Mux'd Output	850/1300nm Low power LED 50µm MMF EF compliant single output FC/PC

Super-Luminescent Light Emitting Diode (SLED) laser Source Module

Part of the MAP Series General Purpose mSRC-C2 family

The Multiple Application Platform (MAP) broadband light source with Super-luminescent Light Emitting Diode lasers (SLED) are stabilized, high power, fixed wavelength emitters with coverage of the key telecom wavelengths of 1310, 1490, 1550 and 1625nm.



VIAVI offers a wide range of SLED sources as part of the general purpose light source (mSRC) module in the MAP portfolio. The SLEDs are offered at nominal wavelengths of 1310nm, 1490nm, 1550nm and 1625nm, with both high power and standard power variants.

Functional Description

VIAVI SLEDs are highly stable sources and offer (figure 1) ± 0.005 dB for standard power configuration and ± 0.01 dB for high-power configuration. Optical

isolators inside the module remove any interference effects from external sources of reflections.

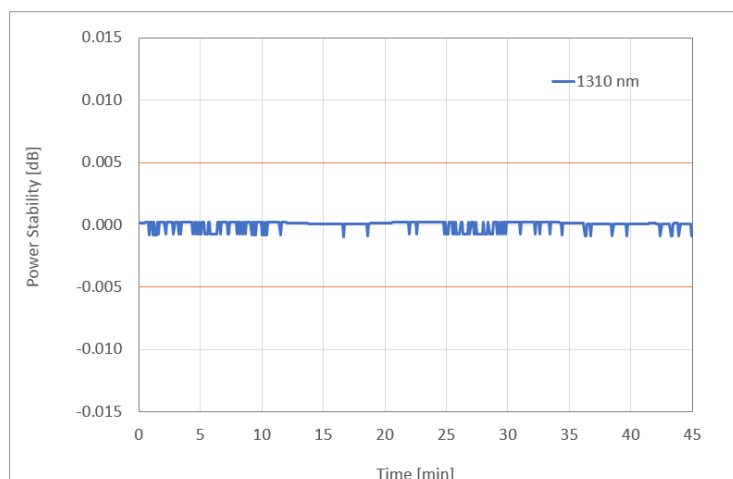

Figure 1: VIAVI High Power SLED Laser Power Stability

Key Features

- 1310nm, 1490nm, 1550nm and 1625nm wavelengths
- High power and standard power versions
- Available in individual and multiplexed versions
- Internal optical isolator to reduce dependence on external reflections

Applications

- Broadband sources for use with optical spectrum analyzers
- CWDM component measurements
- General purpose and interferometry applications

Compliance

- The MAP series mSRC-C2 module, when installed in a MAP chassis, complies to CE, CSA/ UL/IEC61010-1, LXI Class C requirements, meets the requirements of Class 1M in standard IEC 60825-1 (2014), and complies with 21 CFR 1040.1 except deviations per Laser Notice No. 50

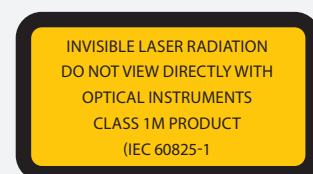

SLEDs have the advantages of LEDs and laser sources, with broadband output and high power (figures 2-4)

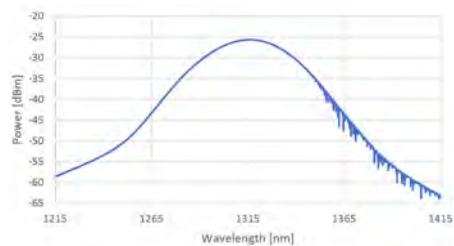

Figure 2: 1310nm SLED Spectral Width

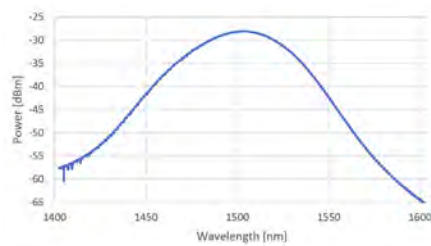

Figure 3: 1490nm SLED Spectral Width

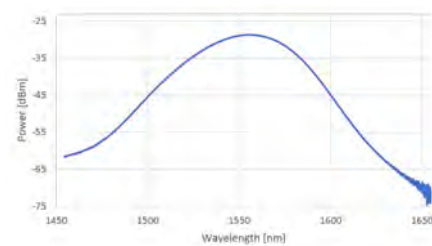

Figure 4: 1550nm SLED Spectral Width

An intuitive graphic user interface (GUI) is optimized for use in either a laboratory or a manufacturing environment. Efficient transition between summary and detailed views allows users to operate at a system level or access the full power of a module.

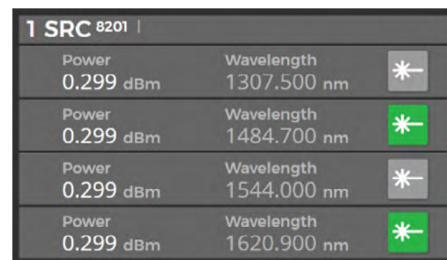

Figure 5: mSRC-C2 MAP-300 summary view GUI

Options and Configurations

The VIAVI SLED sources are offered in standard power and high-power versions.

SLED Variant	Available Configurations
High Power SLED	Single Output 1310 nm
	Dual Output 1310 nm
Standard Power SLED	Individual Output 1310 nm
	Individual Output 1550 nm
	Individual Output 1310 and 1550 nm
	Individual Output 1310, 1490, 1550 and 1625 nm
	Multiplexed Output 1310 and 1550 nm
	Multiplexed Output 1310, 1490, 1550 and 1625 nm

Specifications

For more information on this or other products and their availability, please contact your local VIAVI account manager or VIAVI directly at 1-844-GO-VIAVI (1-844-468-4284) or to reach the VIAVI office nearest you, visit viavisolutions.com/contacts.

Single mode Source (mSRC-C21)	Standard Power SLED Sources (mSRC-C2yyyySL or mSRC-C2yyyySLX)					
Center Wavelength ²	1310 nm	1490 nm	1550 nm	1625 nm	1310/1550 nm mux3	1310/1490/1550/1625 nm mux3
Spectral Width (FWHM) ^{4,5}	> 20 nm	> 30 nm			As per individual specifications	
Output Optical Power ^{3,6}	0 dBm			≥ -4 dBm		≥ -8 dBm
Optical Power Stability for 15 min ³	±0.005 dB			±0.01 dB		
Optical Power Stability for 3 hours ³	±0.005 dB			±0.01 dB		
Spectral Ripple (RB = 0.1nm)	0.2 dB					
TEC Stabilized	Yes					
Wavelength Tolerance	±20 nm					
Optical Power Tuning Range ⁷	≥ 10 dB					
Power Control Mode	Constant Current or Constant Power					
Modulation ⁸	0.15 to 2.0 kHz					
Modulation Accuracy	±0.5 Hz					
Fiber Type	Single Mode Fiber					
Connector Type	FC/APC					

1. All measurements taken after a minimum of 30 minutes warm-up time.
2. Peak wavelength defined as per IEC 61280-1-3 2010 clause 3.1.3. Measured at room temperature.
3. Combined output power. Power measured with any 1 laser on full power at a time.
4. Measured at full power at controlled environment of $\Delta T = \pm 1^\circ\text{C}$, Constant Current mode with PC connector (MM) direct to power meter.

5. Measured with a resolution bandwidth of 0.06 nm.
6. Guarantee of 0 dBm excluding connector losses for non-muxed variant.
7. From maximum power down.
8. Modulation duty cycle is fixed at 50%. Modulation depth is fixed at 100%.

Single mode Source mSRC-C21	SLED High Power Source (mSRC-C23yyyyHS)
Center Wavelength ²	1310 nm
Spectral Width (FWHM) ³	< 60 nm
Output Optical Power ³	≥ 10 dBm
Optical Power Stability for 15 min ³	±0.01 dB
Spectral Ripple (RB = 0.1nm)	0.40 dB
Optical Power Tuning Range	≥ 10 dBm
Modulation	0.15 to 2 kHz
Modulation Setting Resolution	1 Hz
Modulation Accuracy	±0.5 Hz
Power Control Mode	Constant Current or Constant Power
TEC Stabilized	Yes
Wavelength Tolerance	±10 nm
Fiber Type	Single Mode Fiber
Connector Type	FC/APC

1. All measurements taken after a minimum of 30 minutes warm-up time.
2. Defined as per IEC 61280-1-3 2010 clause 8.2.
3. Measured at constant temperature of $23 \pm 5^\circ\text{C}$, at full power.

General Specifications

Parameter	Specification
Operating Temperature	10 to 40 °C (50 to 104 °F)
Storage Temperature	-30 to 60 °C (-22 to 140 °F)
Operating Humidity	Maximum 85% Relative Humidity, non-condensing from 10 to 40 °C/50 to 104 °F
Dimensions (W x H x D)	4.06 x 13.26 x 37.03 cm (1.6 x 5.22 x 14.58 in)
Weight	1.3 kg (2.86 lb)
Warranty	3 years

Ordering Information

Part Number	SLED Single Mode Source		
MSRC-C23000SL-M100-MFA	Standard SLED	Individual Output	1310nm standard power SLED source SMF with FC/APC Connectors
MSRC-C25000SL-M100-MFA			1550nm standard power SLED source SMF with FC/APC Connectors
MSRC-C23500SL-M100-MFA			1310/1550nm standard power SLED source SMF with FC/APC Connectors
MSRC-C23456SL-M100-MFA			1310/1490/1550/1625nm standard power SLED source SMF with FC/APC Connectors
MSRC-C23500SLX-M100-MFA		Single Output (Mux'd)	1310/1550nm SLED source SMF Single output with FC/APC Connectors
MSRC-C23456SLX-M100-MFA			1310/1490/1550/1625nm SLED source SMF Single output with FC/APC Connectors
MSRC-C23000HS-M100-MFA	High Power 1310 SLED	Individual Output	Single 1310 nm high power SLED source with FC/APC Connectors
MSRC-C23300HS-M100-MFA			Dual 1310 nm high power SLED source with FC/APC Connectors

Semiconductor Optical Amplifier (SOA) Module

Part of the MAP Series General Purpose mSRC-C2 family

The Multiple Application Platform (MAP) O-band Optical Amplifier (mSRC-C23000SA/mSRC-C23300SA) is a single or dual channel, polarization-independent semiconductor optical amplifier (SOA). It is a specialized variant of the mSRC-C2 family of stabilized semiconductor light sources.



As loss requirements for 100GE, 200GE and 400GE transmission continue to decrease, optical amplifiers have become a critical element in the test automation tool kit, alongside attenuators, power meters and switches. There are three key reasons that require amplification in a manufacturing test system:

- The base test system automation and the use of attenuators, switches, and mux/demux optics create path losses that exceed the path loss allowance.
- The reference transmitter power is not high enough to achieve an overload condition.
- Tests in manufacturing might be performed in loopback mode, and the DUT TX does not have enough power to achieve overload and guarantee interoperability.

The mSRC-C23000SA and mSRC-C23300SA and provide enough gain to overcome these issues and ensure receivers can be verified over their full dynamic range.

Key Benefits

- > 10 dB of small signal gain in the O-band.
- Saturated output power > +10 dBm.
- Operating range from 1270 to 1340 nm with minimal spectral ripple.
- Polarization independent input.
- Temperature stabilized features.

Applications

- Testing LR4 and LR8 100GE, 200GE and 400GE interfaces.
- RX overload and recovery testing.
- Broadband light source for passive component testing.

Safety Information

- When installed in a MAP chassis, the module complies with CE, CSA/UL/IEC61010-1, LXI Class C requirements, meets the requirements of Class 3B in standard IEC 60825-1 (2014), and complies with 21 CFR 1040.1 except deviations per Laser Notice No. 50, July 2001.

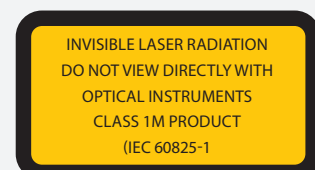

mSRC-C23000SA - Noise Figure and Output Power Vs. Input Power - 100% Current Level

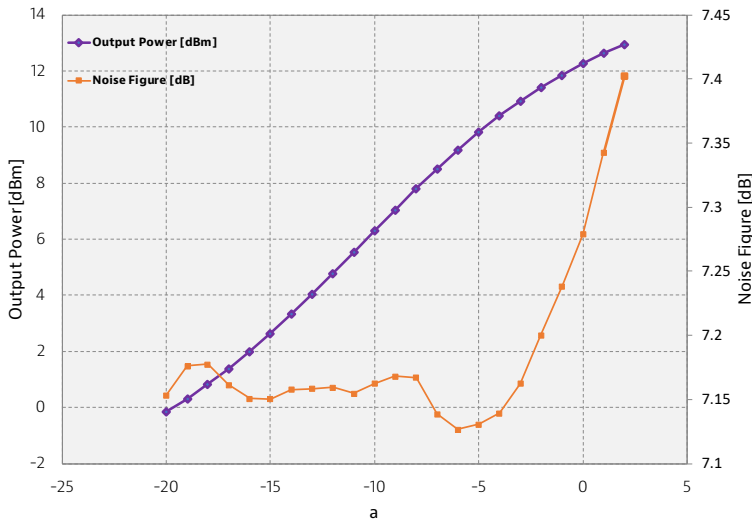

Figure 1 - Example gain vs input power for the mSRC-C23000SA

The bandwidth of the amplifier can support the wavelengths used in the LR4 and LR8 interfaces. When set to the disabled state, the amplifier can provide > 50dB of attenuation and effectively isolate an individual carrier.

Functional Description

The SOA is mainly used to amplify an optical signal directly without the need to convert it to an electrical signal first. The use of the semiconductor as a gain medium increases the optical launch power to compensate for losses in the optical system. Integration of the VIAVI mSRC-C23000SA/mSRC-C23300SA require the use of additional optical modules. Figure 2 and

Figure 3 provide implementation examples. A VOA at the input ensures that the launch power into the SOA is far from saturation. The VOA also ensures the best noise figure by allowing the amplifier to operate at 100%. Optical switches and mux/demux optics automate loopback and eye-mask measurements.

Figure 2 shows a system that enables either an individual lane to be extracted and tested or a loopback test to be performed. This implementation improves eye-mask measurements, with minimal disruption to the loopback test. Figure 3 shows the use of four amplifiers to amplify each lane individually. This implementation allows for overload testing.

If eye-mask or power measurements per lane are required, three of the amplifiers can be set to the disabled state to block unwanted carriers.

In both implementations, care must be taken to ensure minimal return loss at all connection points. Most importantly, ensure that all conditions necessary for safe handling and operation are met while working with optical amplifiers.

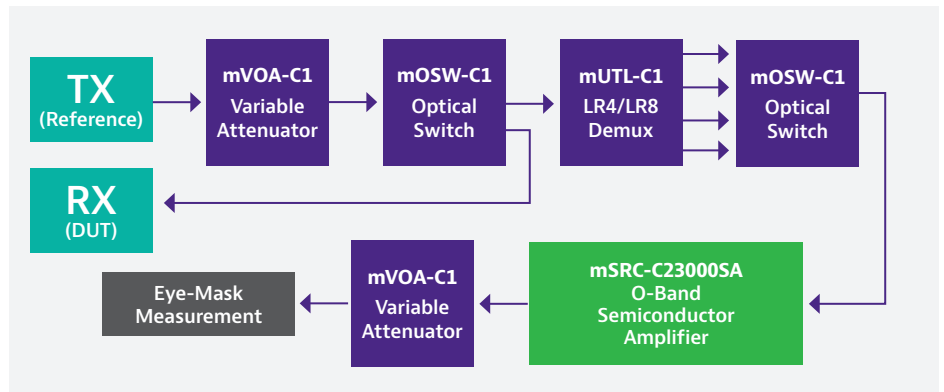

Figure 2 - The amplifier is used to improve eye-mask measurements

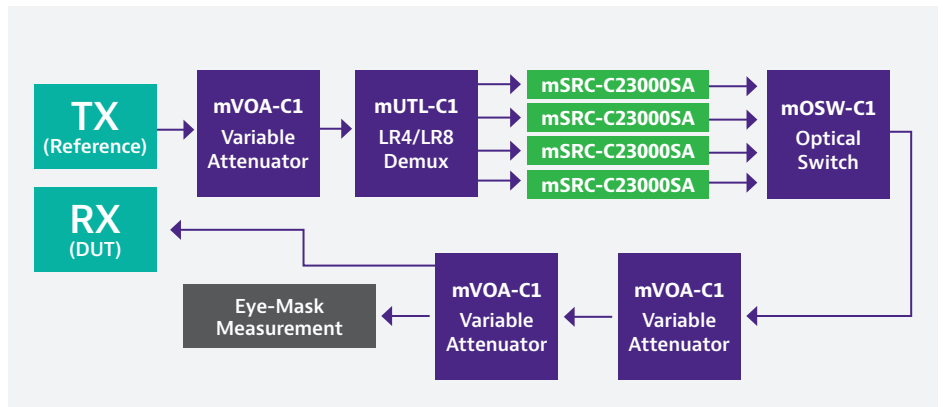

Figure 3 - Four amplifiers (one per carrier) are used to enable overload testing

An intuitive graphic user interface (GUI) is optimized for use in either a laboratory or a manufacturing environment. Efficient transition between summary and detailed views allow users to operate at a system level or access the full power of a module. The GUI provides controls for setting the power level from 10% to 100% or disabling the power entirely.

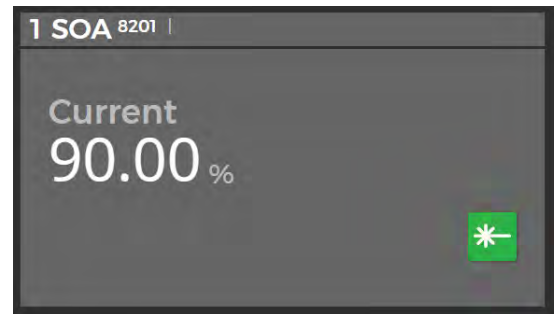

Figure 4 - SOA MAP-300 summary view GUI

Specifications

For more information on this or other products and their availability, please contact your local VIAVI account manager or VIAVI directly at 1-844-GO-VIAVI (1-844-468-4284) or to reach the VIAVI office nearest you, visit viavisolutions.com/contacts.

Specification ^{1,2}	O-band Optical Amplifier (mSRC-C23000SA)
Peak wavelength	1310 nm (228.85 THz)
Operating Wavelength	1270 – 1340 nm (223.73 – 236.06 THz)
Input Power Range	-30 to +3 dBm
Small Signal Gain @ 1310nm -25 dBm input	> 10 dB (13 dB typical)
Saturated Output Power @ 1310nm +3dBm input	> +10 dBm
Noise Figure @ 1310nm -25 dBm input	≤ 9 dB
Polarization Dependent Gain at 1310nm -25 dBm input	≤ 3.5 dB
Attenuation when disabled	> 45 dB
Spectral Ripple (OSA = 0.1 nm)	< 1 dB (0.5 dB typical)
TEC Stabilized	Yes
Power Control Mode	Constant Current
Fiber Type ³	Single Mode
Connector Type	FC/APC
Operation Temperature	10 to 40°C
Operation Humidity	Max 85% RH, non-condensing 10 to 40°C
Storage Temperature	-30 to 60°C
Dimensions (W x H x D)	4.06 x 13.26 x 37.03 (1.6 x 5.22 x 14.58 in)
Weight	1.3 kg

¹All optical measurements were done after minimum 30 minutes warming up

²Maximum current, controlled environment 23±1°C, APC connector (SM) direct to power meter or OSA

³For IEC 60793-2-50 Type B1.3/ ISO 11801 OS2-compliant single-mode fiber

Ordering Information

Part Number	Description
MSRC-C23000SA-M100-MFA	O-band Semiconductor Optical Amplifier SMF FC/APC
MSRC-C23300SA-M100-MFA	Dual 1310 nm Semiconductor Optical Amplifier SMF FC/APC

© 2020 VIAVI Solutions Inc.
 Product specifications and descriptions in this document are subject to change without notice.
 mscr-c2-oband-ds-lab-nse-ae
 30186398 904 0920

Optical Signal Conditioning

VIAVI offers signal conditioning modules, that can attenuate, amplify, filter out channels, control polarization, or simulate back reflection. They are able to manage, control and emulate the optical layer loss, length, polarization and wavelength filtering. The modules can stress test optical interfaces to verify they will work at the specified conditions when in the field.



Variable Back Reflector (mVBR-C1)

MAP Series Metrology Grade Optical Back Reflector

The MAP Series Variable Back Reflector (mVBR-C1) cassette provides precise levels of return loss to transmitters, enabling measurement of system sensitivity and system degradation as a function of back reflection.



Together with a transmitter/receiver pair and characterization equipment, the MAP back reflector can be used to establish the magnitude of reflections that significantly degrade transmission system performance, and to characterize the problems they cause.

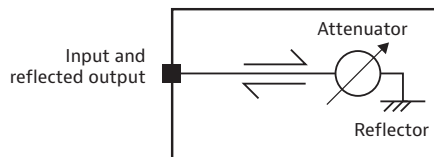

The MAP backreflector uses the VIAVI linear attenuator prism and high reflectivity mirror to precisely control the level of RL.

The cassette is available in single-mode (SM) or multimode (MM) fibers and with an optional coupler for monitoring.

Benefits

- Single-mode and multimode variants
- Can be automated when used with a MAP series mainframe LXI-compliant interfaces and IVI drivers
- Can be combined with other MAP-Series modules to perform IEEE standard testing
- 0.002 dB resolution
- Operation at 850/1310 or 1310/1550 nm

Applications

- Transmitter/receiver development and testing
- Reflection testing for connectors
- Quality assurance acceptance testing
- Laser development and production
- Validation instrument for verifying RL equipment
- R&D compliance testing
- OTDR testing

Safety Information

Complies with CE, CSA/UL/IEC61010-1, plus LXI class C requirements when installed in a MAP chassis

Functional Description

In transmission systems, power fluctuations due to back reflection distort the signal and translate to an increased bit error rate, which can be measured as a function of back reflection.

MAP Series mVBR cassettes are used to study the effects of varied back reflected signals on transmitter or laser performance. Figure 1 shows a typical test configuration using the mVBR cassette and an external coupler. With this configuration, the coupler splits the light injected from the source, sending a portion of it to the mVBR and the rest to the test system.

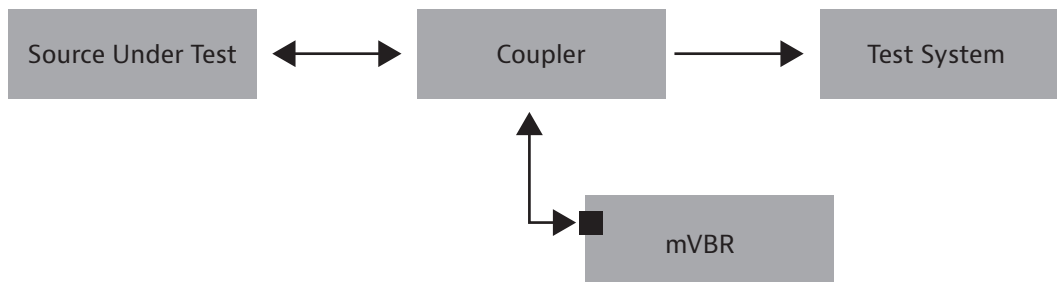

Figure 1 - Test configuration - mVBR cassette and external coupler

An offset setting can be configured on the mVBR to compensate for losses occurring at connectors and through any additional components between the source and the mVBR.

An intuitive graphic user interface (GUI) is optimized for use in either a laboratory or a manufacturing environment.

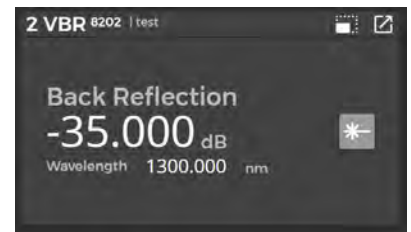

Figure 2 – mVBR MAP-300 summary view GUI

Specifications

Parameters	Single-Mode	Multimode
Wavelength Range	1260 to 1650 nm	750 to 1350 nm
Maximum Back Reflection Level	- 5.0 dB	
Minimum Back Reflection Level	- 60 dB	- 35 dB
Back Reflection Resolution	0.005	
Repeatability ^{2, 3, 4}	± 0.02 dB	
Absolute Back Reflection Accuracy ^{1,2,3}	±0.3 dB	±0.6 dB
Relative Back Reflection Setting Accuracy ^{1,2,3}	±0.05 dB	±0.35 dB
Polarization Dependent Back Reflection ¹	< 0.15 dB	N/A
Maximum Optical Input Power	200 mW	
Fiber Type	9/125 μm	50/125 μm
Connector Type	FC/APC	FC/PC
Warm-up time	30 minutes	
Calibration Period	1 year	
Operating Humidity	15 to 80% RH, 0 to 40°C noncondensing	
Operating Temperature	0 to 50°C	
Storage Temperature	-30 to 60°C	
Dimensions (W x H x D)	4.1 x 13.3 x 37.0 cm (1.6 x 5.22 x 14.58 in)	
Weight	1.1 kg (2.42 lbs)	

1. At 1310 nm ±15 nm and 1550 nm ±15 nm for SM variant; 850 nm ±15 nm and 1300 ±15 nm for MM variant

2. At 23 ±5°C

3. Source line width > 500 MHz

4. Maximum measured difference between consecutive 25 dB back reflection settings, separated by a random setting. Observed for 100 measurements

Ordering Information

For more information on this or other products and their availability, please contact your local VIAVI account manager or VIAVI directly at 1-844-GO-VIAVI (1-844-468-4284) or to reach the VIAVI office nearest you, visit viavisolutions.com/contacts.

Available Configurations

Order Code	Description
MVBR-C1SS0-M100-MFA	Single VBR Single Mode Fiber FC/APC no tap option
MVBR-C1SS0-M101-MFP	Single VBR Multi-Mode Fiber 50μm FC/PC no tap option

© 2020 VIAVI Solutions Inc.
 Product specifications and descriptions in this document are subject to change without notice.
 mvbr-c1-ds-lab-nse-ae
 30192802 900 0920

Variable Optical Attenuators (mVOA-C1)

MAP Series Metrology Grade Optical Attenuator

The Multiple Application Platform (MAP series) Variable Optical Attenuator (mVOA-C1) is a stepper motor and filter-based attenuator that delivers metrology-grade programmable attenuation performance in the industry's most compact package.



With more than 30 years of leadership in high-performance attenuators for lab and manufacturing applications, the mVOA-C1, is now in its fifth generation. The mVOA is a high-resolution, wide wavelength-range attenuator ideal for use in applications such as amplifier testing, 100/400GE client optic testing and stressing advanced next generation coherent long haul interfaces. The attenuator is built on proven industry leading technology for maximum reliability and performance.

The module is available in single-mode or multimode fiber, supports multiple optical connectors and has versions with either an

output tap or integrated power meter control. The power control option can function as an in-line power monitor. It is available in single, dual, or quad configurations, all in single slot modules. Up to 48 independently controlled attenuators can be installed in a single 8-slot MAP chassis.

The MAP variable optical attenuator is hot-pluggable and designed for use with all versions of the MAP series chassis family.

The mVOA has low, industry leading, insertion loss (<0.9 dB) and exceptional spectral and attenuation uniformity, thus minimizing loss budget. Making the mVOA ideal for CWDM and DWDM test applications. The attenuation accuracy (± 0.01 dB) and repeatability (± 0.015 dB) are key to enabling manufacturing test systems that maximize test yield.

Key Features and Benefits

- Ultra-low insertion loss (<0.9 dB) and outstanding spectral uniformity minimize loss budget utilization
- Fastest transition speed and settling time in its class reduces testing time
- Optional built-in power monitor provides comprehensive closed-loop power control settings
- Optional higher power capability can withstand up to 2W input power for single mode fiber (500 mW for multimode fiber)

Applications

- High accuracy and high repeatability reduces measurement uncertainty
- Flat spectral response reduces wavelength dependent uncertainty in CWDM and DWDM multi-wavelength applications
- Low back-reflection
- Optional built-in wavelength calibrated power meter
- High input power capability for EDFA testing and multi-wavelength applications

Compliance

- Complies with CE, CSA/UL/IEC61010-1, plus LXI class C requirements when installed in a MAP chassis

Functional Description

The mVOA provides attenuation through an expanded beam modified by a linearly variable neutral density filter. Precision optical design, optimized over 30 years, is key to guaranteeing low IL/RL and PDL. Management of the attenuated light is carefully considered in order to ensure high power performance and long-term reliability. Proprietary motor control algorithms paired with a kinematic drive delivers high speed attenuation change with industry leading settling time and stability.

There are two modes of operation, attenuation mode and power mode. Attenuation mode, the most basic form of operation, changes the insertion loss of the module without consideration for the input power. Power mode sets the absolute power at the output of the mVOA and requires the internal power meter option. When in power mode, input power tracking can be enabled, which automatically adjusts the mVOA to keep the output power constant. Multiple power and attenuation offsets are available to compensate for test system losses and simplifies test system integration.

An intuitive graphic user interface (GUI) is optimized for use in either a laboratory or a manufacturing environment. Efficient transition between summary and detailed views (figure 1 and figure 2) allow users to operate at a system level or access the full power of a module.



Figure 1 – mVOA MAP-300 summary view GUI

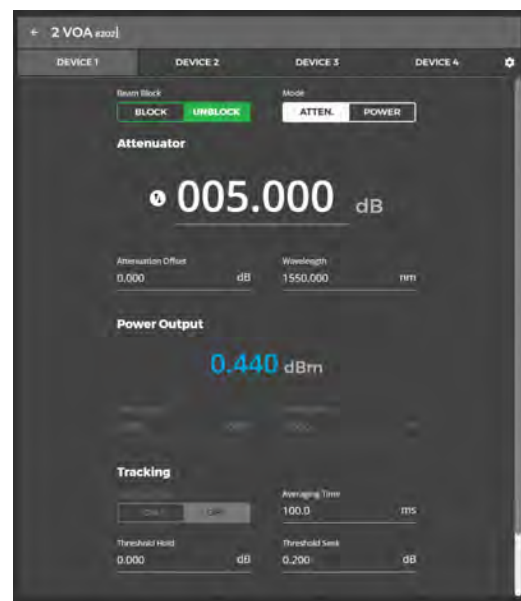

Figure 2 – mVOA MAP-300 detailed view GUI

Options and Configurations

The mVOA can be configured in three possible ways,

- 1. Standard attenuator (figure 3a):** This configuration operates in attenuation mode only. To control output power, measurement of the input power is required prior to testing.
- 2. Attenuator with output tap (figure 3b):** This configuration operates in attenuation mode only. An output tap (5% for single mode and 10% for multimode) allows the output power to be monitored on an external power meter.
- 3. Attenuator with output power monitoring (figure 3c):** This configuration operates in either attenuation or output power mode. Output powers can be set directly. When tracking is enabled the attenuator dynamically adjusts for input power changes.

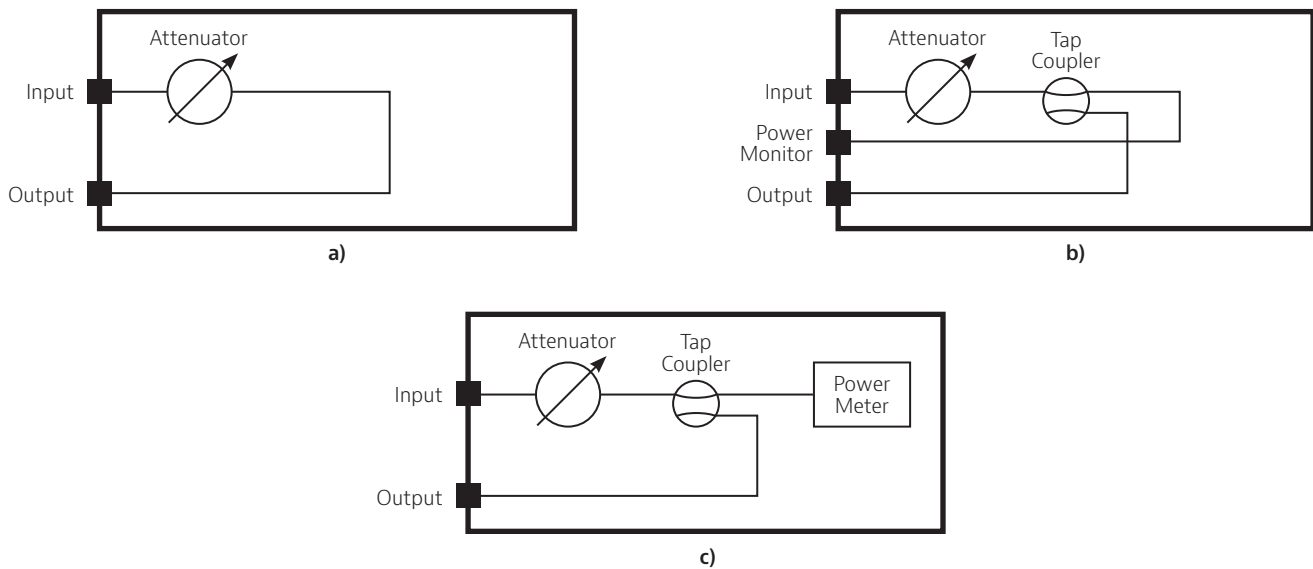

Figure 3 – Optical Configurations of the mVOA module, a) Standard attenuator; b) Attenuator with output tap; c) Attenuator with output power monitoring

Specifications

Parameters	Single-Mode		Multimode	
	Standard	With Output Power Monitor	Standard	With Output Power Monitor
Insertion loss at 0dB ^{1,2,3,4}	≤0.9 dB (≤1.5 dB tap option)	≤1.5 dB	≤1.5 dB (≤2.4 dB tap option)	≤2.4 dB
Polarization-dependent loss ⁵	≤ 0.08 dB (≤0.15 dB tap option)	≤0.15 dB	N/A	
Return loss ^{1,2,6}	≥55 dB		≥45 dB	
Maximum input power ⁹ (standard power/high-power option)	+23 dBm/+33 dBm		+23 dBm/+27 dBm	
Wavelength range	1260 to 1650 nm		750 to 1350 nm	
Attenuation range ^{1,2}	70 dB		65 dB	
Shutter isolation	≥80 dB		≥75 dB	
Attenuation flatness ^{8,10}	±0.04 dB		N/A	
Attenuation slew rate	≥25 dB/s		≥20 dB/s	
Relative attenuation uncertainty ^{1,2,3,7,10,11,13}	±0.1 dB			
Attenuation repeatability ^{3,7,11,13}	±0.01 dB			
Attenuation resolution ¹⁴	0.001 dB			
Attenuation settling time	≤55 ms			
Closed-loop power range ^{1,2} (standard power/high-power option)	N/A	+11 to -49 dBm / +31.5 to -28.5 dBm	N/A	+5 to -40 dBm
Power monitor linearity ^{1,2,3,10}	N/A	±0.03 dB	N/A	±0.03 dB
Power setting repeatability ^{1,2,10}	N/A	±0.015 dB	N/A	±0.015 dB
Power setting resolution	N/A	0.001 dB	N/A	0.001 dB
Warm-up time	30 min			
Calibration period	1 year			
Operating temperature	0 to 50°C			
Storage temperature	-30 to 60°C			
Operating humidity	15 to 80% RH, 0 to 40°C noncondensing			
Dimensions (W x H x D)	4.1 x 13.3 x 37.0 cm			
Weight	1.1 kg (single) / 1.3 kg (dual) / 1.7 kg (quad)			

1. At both 1550 ±15 nm and 1310 ±15 nm for single-mode.

2. At both 850 ±15 nm and 1310 ±15 nm for multimode.

3. +23/-5°C only.

4. Excludes connectors, add 0.2 dB typically for connectors.

5. For 0 to 25 dB.

6. Return loss excludes connectors.

7. For range of 0 to 45 dB.

8. For range of 0 to 30 dB over 1480 to 1640 nm.

9. Input to output port only.

10. For light with DOP <5%.

11. For low-coherence laser source (>500 MHz).

12. Consecutive measurements.

13. Relative to 0 dB position.

14. 0 to 65 dB for single-mode, 0 to 50 dB for multimode.

Ordering Information

For more information on this or other products and their availability, please contact your local VIAVI account manager or VIAVI directly at 1-844-GO-VIAVI (1-844-468-4284) or to reach the VIAVI office nearest you, visit viavisolutions.com/contacts.

All mVOA-C1 attenuators are configured by a single part number that defines the function and options of the module. The XXX code defines the fiber type, as seen in table 1, and the YY code defines the connector type, as seen in table 2.

Available Configurations

Power Type	Order Code	Description
Standard Power	MVOA-C1SS0-MXXX-MYY	Single VOA, Standard Power, No Option
	MVOA-C1DS0-MXXX-MYY	Dual VOA, Standard Power, No Option
	MVOA-C1QS0-MXXX-MYY	Quad VOA, Standard Power, No Option
	MVOA-C1SSM-MXXX-MYY	Single VOA, Standard Power, Monitor Option
	MVOA-C1DSM-MXXX-MYY	Dual VOA, Standard Power, Monitor Option
	MVOA-C1QSM-MXXX-MYY	Quad VOA, Standard Power, Monitor Option
	MVOA-C1SS1-M100-MYY	Single VOA, Standard Power, Tap Option, Single Mode Fiber
	MVOA-C1DS1-M100-MYY	Dual VOA, Standard Power, Tap Option, Single Mode Fiber
	MVOA-C1QS1-M100-MYY	Quad VOA, Standard Power, Tap Option, Single Mode Fiber
	MVOA-C1SSE-M100-MYY	Single VOA, Standard Power, Extended Range Option, Single Mode Fiber
High power	MVOA-C1SH0- MXXX-MYY	Single VOA, High Power, No Option
	MVOA-C1DH0- MXXX-MYY	Dual VOA, High Power, No Option
	MVOA-C1SHM- MXXX-MYY	Single VOA, High Power, Monitor Option
	MVOA-C1DHM- MXXX-MYY	Dual VOA, High Power, Monitor Option
Licenses	MSUP-300A-4VOAPWC	MAP-300 License to enable 4 VOA cassettes to use external power control
	MSUP-300A-8VOAPWC	MAP-300 License to enable 8 VOA cassettes to use external power control

Table 1

XXX code	Fiber Type
M100	9µm Single Mode
M101	50µm (OM3)
M102	62.5µm (OM1)

Table 2

YY Code	Connector Type
MFP	FC/PC
MFA	FC/APC
MSC	SC/PC
MSU	SC/APC
MLC	LC/PC
MLU	LC/APC

Multiport Tunable Filter Module (mTFX-C1)

MAP Series 100G+ Wavelength Management Filter

The Multiple Application Platform (MAP series) multiport tunable filter module (mTFX-C1) dramatically simplifies test signal management for next-generation 100 G+ interfaces, sub-systems, and system test.

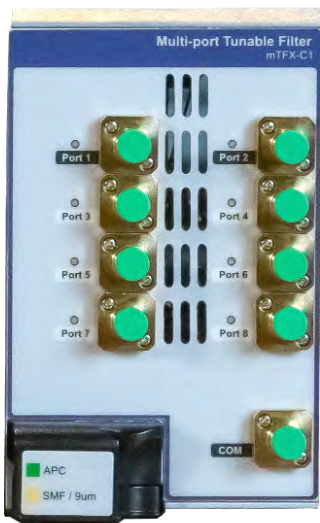

Get the right wavelengths to the right test port with the right power—quickly. Flexibly isolate, groom, manage, and route any wavelength or group of wavelengths with a simple, intuitive GUI and/or SCPI based remote commands. The mTFX-C1 is a modular instrument and can be directly managed from your PC-based automation system. It eliminates the need to re-purpose optical network technology or use complex libraries with specialized interface cards.

Benefits

- Tunable filter with bandwidth adjustment from 6.2 to 5100 GHz with 0.5 GHz resolution.
- Offered in C- and L-bands.
- Low loss continuous extended C-band or L-band coverage with ± 3.5 GHz wavelength accuracy.
- Automated peak tracking function without loss of transmitted power.

Key Features

- Up to 120 independent filters, each with independent attenuation and output port assignment.
- New filters can be added and removed without disturbing existing connections.
- Internal power meter option with automated single and multiple peak find algorithms.
- Center frequency and bandwidth resolution < 10 pm.
- Fast, simple GUI and SCPI control interfaces for filter generation.
- Optional SW license to enable up to 8 output ports.

Applications

- Transmitter dispersion, eye mask, and receiver sensitivity testing
- Photonic communication test automation.
- 100 G+ coherent interface testing.
- ROADM node emulation.
- Signal extraction or insertion during DWDM system testing.
- Amplifier gain spectrum management and load tone generation.
- OSNR measurements.

Safety Information

- Complies with CE, CSA/UL/IEC61010-1, plus LXI class C requirements when installed in a MAP chassis.

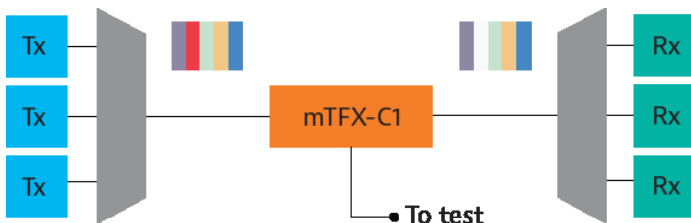

Drop and groom channel with ideal or stressed filter shape

Figure 1 - Example application: isolate (drop) a signal from a DWDM test system and route to a test application while expressing all other wavelengths to other receivers

Functional Description

Based on next-generation liquid crystal on silicon (LCOS) technology, the mTFX-C1 is much more than a tunable filter. It combines variable attenuator, switch, power meter, and DWDM multiplexer functions to dramatically simplify photonic testing of coherent interfaces, amplifier, and DWDM systems. Leveraging TrueFlex™ technology, filters are continuously tunable in center wavelength and bandwidth and are not locked to the ITU grid.

Multiple parallel wavelength paths can be created without disrupting already established connections—all with sub-GHz resolution. Industry leading specifications for loss and out-of-band rejection ensure minimal impairments on your test signals. The tunable filter is offered in the C- and L-bands variant with the option of power monitor.

To simplify interaction and programming, control of the mTFX-C1 has been divided into simple, easy-to-visualize functional blocks. A “virtual filter” is defined by a center wavelength, bandwidth, shape, and attenuation. A virtual filter can be easily moved anywhere in the C-band or L-band through assignment of the center wavelength. The virtual switch allows the filter to be expressed to a physical output port. Up to 120 virtual filters can be created and independently controlled. To manage assignment conflicts, a slice of spectrum may only be assigned to one output port at a time (although multiple independent slices can go to the same port).

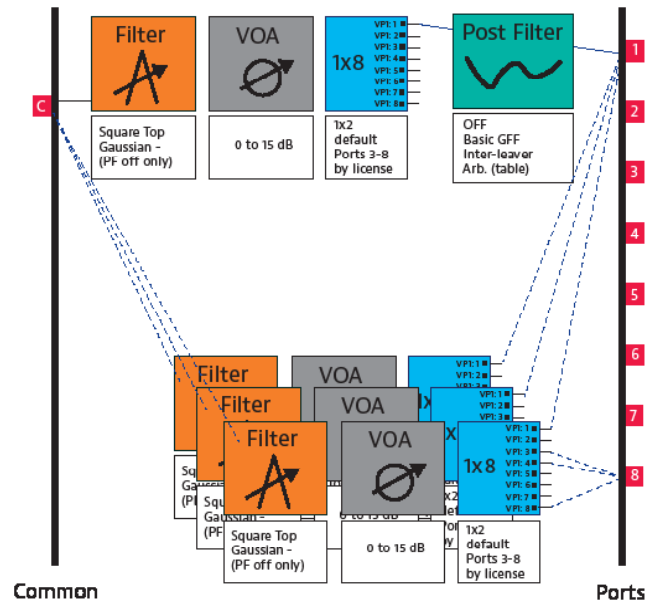

Figure 2 - The mTFX-C1 showing individual control blocks

An intuitive graphic user interface (GUI) is optimized for use in either a laboratory or a manufacturing environment. Efficient transition between summary and detailed views (figure 3 and figure 4) allow users to operate at a system level or access the full power of a module. The mTFX-C1 has a more complex GUI than many of VIAVI's other modules due to its three modes of operations, channel mode, full mode and shape mode.

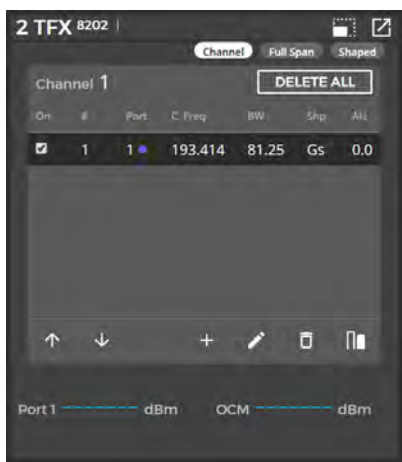

Figure 3 - mTFX MAP-300 summary view GUI

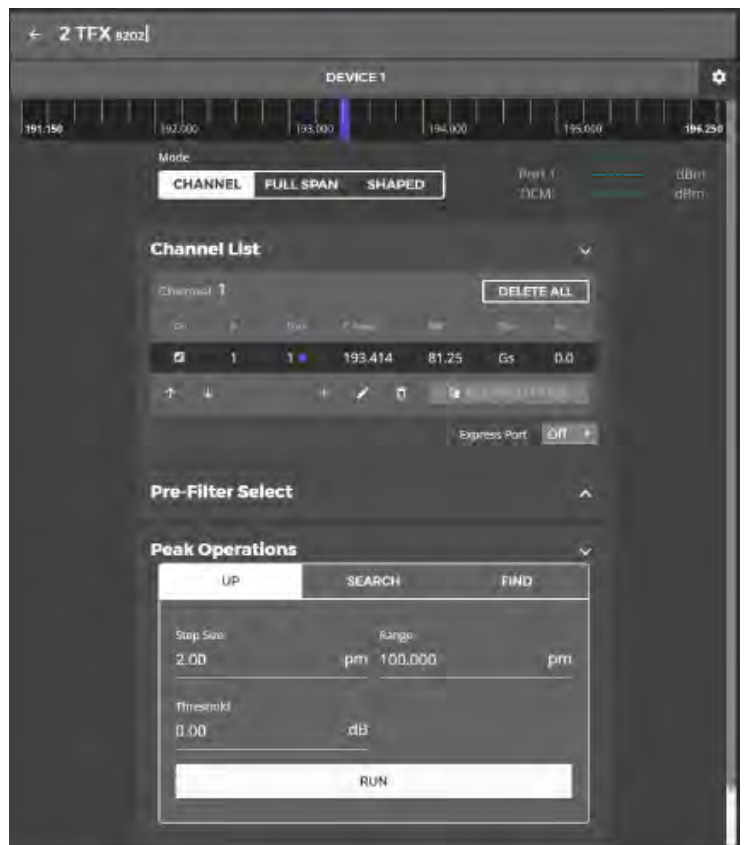

Figure 4 - mTFX MAP-300 detailed view GUI

Tunable Filter Modes

Three control modes are available to further simplify use and let a user tailor the level of complexity they require.

1) Channel mode

Channel mode is the basic operation mode. In this mode, the post-filter has been disabled. This allows for powerful yet simple control of individual virtual filters. This mode supports both square and Gaussian shaped filters. Square top modes are ideal for ROADM emulation and systems employing multiple carriers in the channel. Gaussian shapes are ideal where it is critical to have the filter center wavelength and the carrier tightly aligned. Any drift in the carrier results in an unambiguous decrease in the power of the signal. Channel mode also includes an automated express capability. In a single command, the unfiltered spectrum is automatically routed to the selected port.

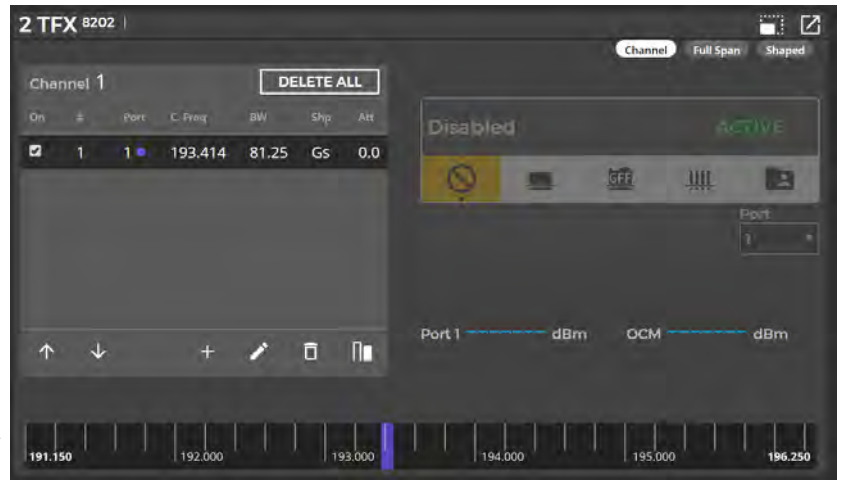

Figure 5 – Channel mode displayed on the MAP-300 GUI

If the internal power meter option is selected, three powerful peak-signal detection functions become available.

- Peak Find: Measures the center frequency of any peak with a power level above a threshold; the signal is blocked while executing.
- Peak Search: Searches for the highest power signal within user defined start, stop and step wavelengths. A Gaussian channel centered on the peak frequency is created.
- Peak Up: Optimizes the placement of an isolation filter around a signal to maximize the transmitted power and minimizing the insertion loss.

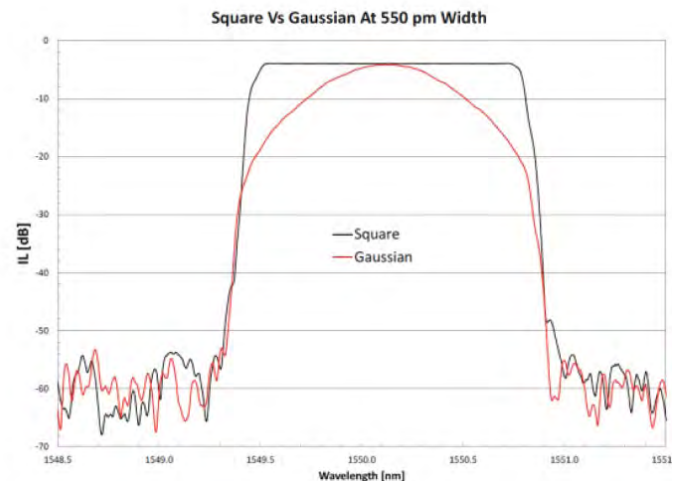

Figure 6 – Square and Gaussian filter using the mTFX

2) Full Span Mode

Full span mode, disables the virtual filters and allows the unit to be operated like a simple single-port programmable filter. The primary intention of this mode is to shape the full transmitted spectrum and it is an ideal tool to generate frequency combs, gain tilt, and gain shape corrections. Standard programmable shapes are available, and users may upload up to five custom shapes. Prefilters available include, loss flattening filter, EDFA Gain-flattening filter and comb filter.

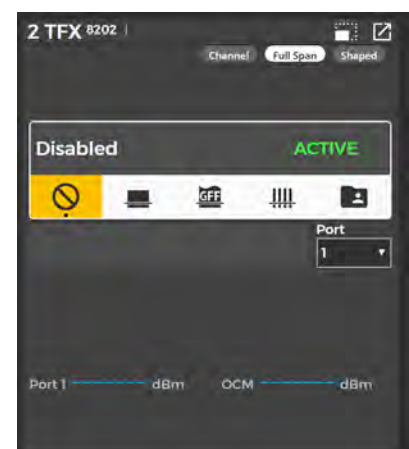

Figure 7 – Full-span mode displayed on the MAP-300 GUI

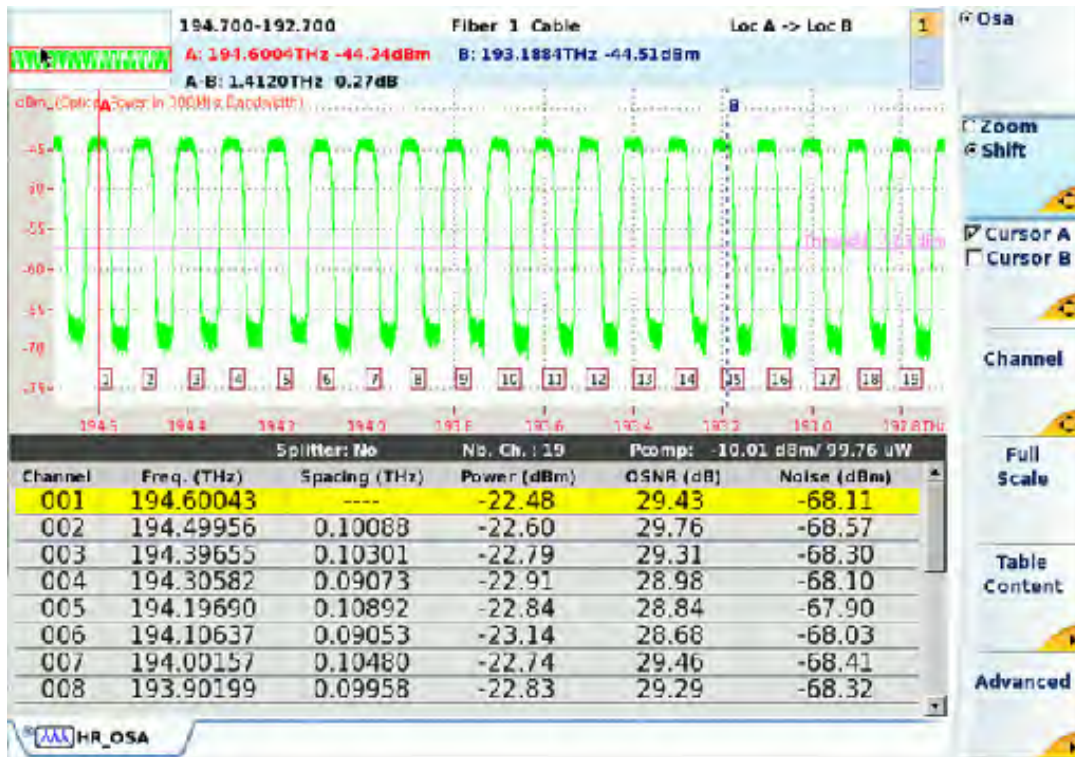

Figure 8 – Example of a TFX comb filter displayed on the HR_OSA

3) Shape mode

Shape mode combines the power of Channel and Full mode. Together, they enable the generation of more complex filtering patterns while retaining a simple and intuitive interface. In this mode, the virtual filter attenuation profile is modified by the presence of the Full mode attenuation shape.

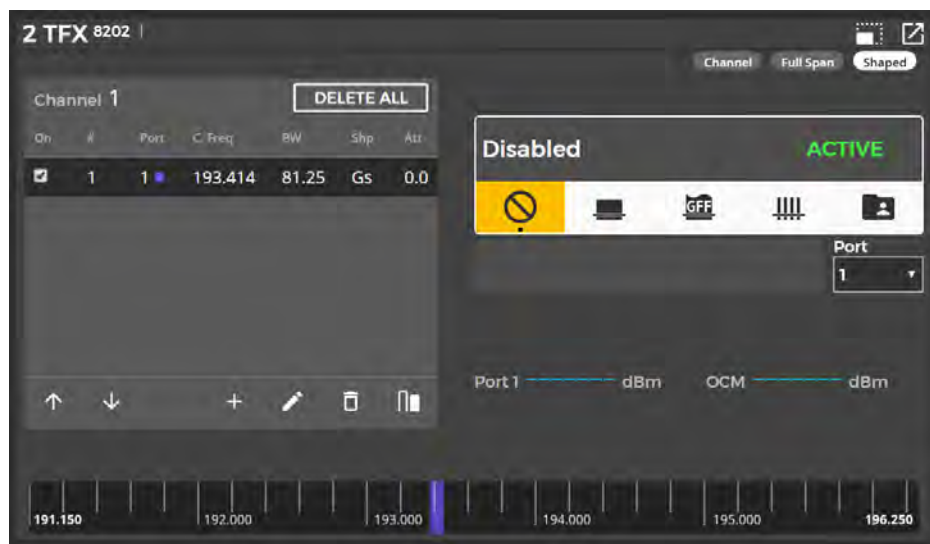

Figure 9 – Shape mode displayed on the MAP-300 GUI

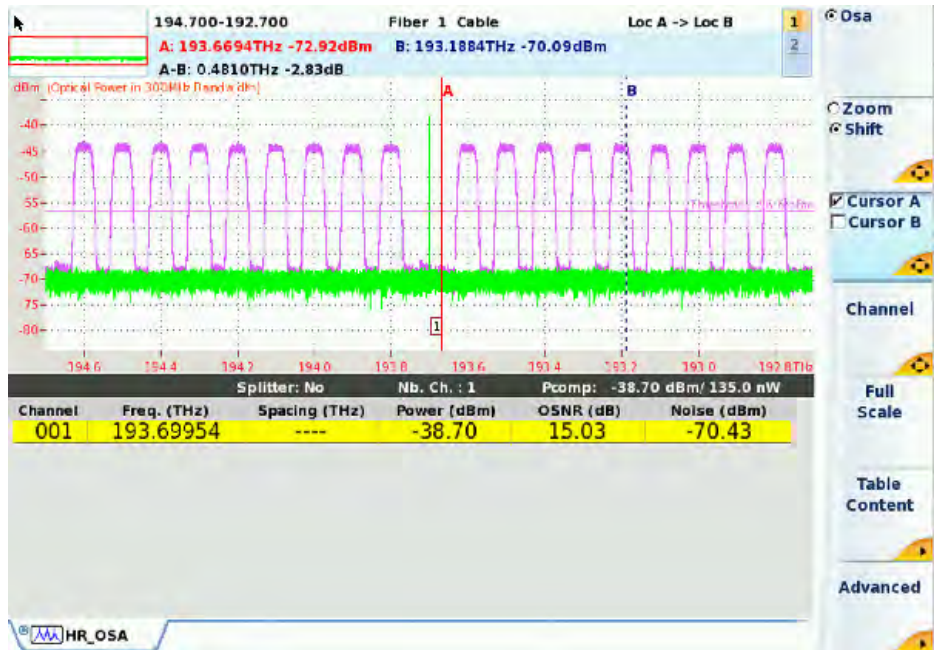

Figure 10 – Using the shape mode in the mTFX to combine a comb filter and a low pass and high pass filter to remove a single channel. Displayed on the HROSA

Specifications

Parameter	C-Band	L-Band
Frequency Range	191.15 to 196.25 THz 1527.61 to 1568.35 nm	186.30 to 191.05 THz 1569.19 to 1609.19 nm
Number of Active Output Ports	2 Note: 4 or 8 ports available with additional software license.	
Number Independent User Defined Filters	120 (maximum)	
Standard Filter Shapes	Square top and Gaussian top (valid up to 20 dB attenuation)	
Insertion Loss¹		
Port 1 standard configuration	< 5.5 dB	< 6.0 dB
Port 1 with power monitor option	< 6.0 dB	< 6.5 dB
Ports 2 to 8	< 6.0 dB	< 6.5 dB
Short-term Insertion Loss Stability²		
Averaging time < 10 ms	± 0.05 dB	
Averaging time > 10 ms	± 0.01 dB	
Insertion Loss Repeatability ³	± 0.025 dB	
PDL ⁴	< 0.3 dB (typical) from 0 to 10 dB attenuation	
Return Loss ⁵	> 30 dB	
Square Top Filter Bandwidth ⁶	6.2 to 5100 GHz	6.2 to 4800 GHz
Maximum Bandwidth for Gaussian Filter Shape	250 GHz	
Center Wavelength and Bandwidth Resolution	0.5 GHz	
Center Frequency Accuracy ⁷	± 3.5 GHz (typical) ± 5 GHz (maximum)	
Maximum Input Power		
For single 12.5 GHz channel	13 dBm	9 dBm
Broad Band Source	24 dBm	
Max Attenuation Range		
Gaussian Profile	10 dB	
Square Top Profile	20 dB	15 dB
Attenuation Setting Resolution	0.1 dB	
Single Filter, Average Out of Band Rejection ⁸	> 40 dB	
Group Delay Variations		
Gaussian Top, over 3 dB bandwidth	< 5.0 ps	
Square Top, over 80% of bandwidth	< 4.0 ps	
Differential Group Delay		
Gaussian Top, over 3 dB bandwidth	< 2.0 ps	
Square Top, over 80% of bandwidth	< 0.3 ps	
Warm-up Time	60 min	
Operating Temperature	0 to 45°C	

Specifications continued

Parameter	C-Band	L-Band
Storage Temperature	-30 to 60°C	
Operating Humidity	Maximum 85% Relative Humidity, non-condensing from 10 to 40 °C	
Dimensions	8.1 x 13.26x 37.03 cm	
Weight	2.4 kg (5.4 lbs)	

¹ Includes one optical connector. Measured using depolarized light source. For filters with bandwidth >20 GHz.

² Measured using a depolarized light source. Values at center wavelength with no attenuation applied. Values reported are 3 measured over 20,000 samples at the indicated averaging time.

³ Min-max, Insertion Loss variation measured using depolarized source at the center wavelength. Measured by activating and deactivating filter at the same wavelength on the same output port.

⁴ PDL is valid at the Gaussian minimum loss or over 80% of square top bandwidth.

⁵ Excludes directivity. Measured into a common port when all other channels are routed to outputs.

⁶ Bandwidth is specified at 0.2 dB loss level relative to the minimum filter insertion loss. Allocated spectrum based on square top filter definition. Selection of Gaussian profile will reduce the effective bandwidth of the channel.

⁷ Center wavelengths is measured at 3 dB and 10 dB levels relative to minimum loss in the filter.

⁸ Ratio of filter minimum IL to background maximum from a spectrum ranges that would represent a higher and lower frequency adjacent channel.

Ordering Information

For more information on this or other products and their availability, please contact your local VIAVI account manager or VIAVI directly at 1-844-GO-VIAVI (1-844-468-4284) or to reach the VIAVI office nearest you, visit viavisolutions.com/contacts.

Category	Connector	C-Band		L-Band	
		Part Number	Description	Part Number	Description
Without Power Monitor	FC/APC	MTFX-C111C008C0-M100-MFA	C-band multiport tunable filter SMF FC/APC	MTFX-C111C008L0-M100-MFA	L-band multiport tunable filter SMF FC/APC
	FC/PC	MTFX-C111C008C0-M100-MFP	C-band multiport tunable filter SMF FC/PC	MTFX-C111C008L0-M100-MFP	L-band multiport tunable filter SMF FC/PC
	SC/APC	MTFX-C111C008C0-M100-MSU	C-band multiport tunable filter SMF SC/APC	MTFX-C111C008C0-M100-MSU	L-band multiport tunable filter SMF SC/APC
	SC/PC	MTFX-C111C008C0-M100-MSC	C-band multiport tunable filter SMF SC/PC	MTFX-C111C008L0-M100-MSC	L-band multiport tunable filter SMF SC/PC
With Power Monitor	FC/APC	MTFX-C111C008CM-M100-MFA	C-band multiport tunable filter SMF FC/APC with power monitor	MTFX-C111C008LM-M100-MFA	L-band multiport tunable filter SMF FC/APC with power monitor
	FC/PC	MTFX-C111C008CM-M100-MFP	C-band multiport tunable filter SMF FC/PC with power monitor	MTFX-C111C008LM-M100-MFP	L-band multiport tunable filter SMF FC/PC with power monitor
	SC/APC	MTFX-C111C008CM-M100-MSU	C-band multiport tunable filter SMF SC/APC with power monitor	MTFX-C111C008LM-M100-MSU	L-band multiport tunable filter SMF SC/APC with power monitor
	SC/PC	MTFX-C111C008CM-M100-MSC	C-band multiport tunable filter SMF SC/PC with power monitor	MTFX-C111C008LM-M100-MSC	L-band multiport tunable filter SMF SC/PC with power monitor

Polarization Controller (mPCX-C1)

MAP Series high speed polarization scrambler, controller and stabilizer

The Multiple Application Platform (MAP-Series) Polarization Control Module (mPCX-C1) is a single slot high-speed polarization scrambler, controller and stabilizer. With the rise of coherent modulation formats and polarization multiplex systems, there is a new premium on understanding the way the polarization state of these signals interacts with single-mode fiber. The mPCX-C1 module is designed to enable these tests, not only in the laboratory, but also in the transition of these tests to a manufacturing environment.



At its core, the mPCX-C1 cascades eight quarter wave-plates. Based on Lithium-Niobate, the electro-optic wave-plates have the response time required by the most demanding polarization management applications. These wave-plates can be rotated at high speed and are reset-free (endlessly rotatable) to control the state of polarization (SOP).

Simple, predefined, rate-programmable, and polarization scrambling modes are provided which can achieve rates up to 3M rad/s. Alternatively, user-defined tables can be uploaded for custom scrambling patterns. With the proprietary SOP feedback option, two features are unlocked. The first enables an identified state to hold while the mPCX-C1 counteracts normal environmental drift and the second simplifies the automatic generation of unique diagnostic scrambling modes.

Key Features

- High-speed polarization scrambler, rate programmable from 1.00 rad/s to 3.00 Mrad/sec
- Operation in C/L, O and All-band with less than 3dB of Insertion Loss
- Uniform scrambling by design, independent of input state of polarization
- Six advanced scrambling modes including Rayleigh, Random and Ring
- Polarization stabilization and return-to-state capability with proprietary SOP feedback option
- Manual polarization control via classic waveplates
- Compact single slot module

Applications

- Photonic communication test automation
- 100G+ coherent interface testing
- Temporal depolarizer for loss, gain and PDL min/max measurements
- Stabilization and tracking of target SOP

Compliance

- CE, CSA/UL/IEC61010-1, and LXI Class C requirements (when installed in a MAP chassis)

Functional Description

The mPCX-C1 has two basic operational modes:

Direct Wave-plate Control

In wave-plate mode, the angles of individual wave-plates can be controlled directly. Static angles or rotational velocities can be set. The user can select between two control modes; two quarter wave-plates (Q-Q configuration) or two quarter waveplates separated by a half-wave-plate (Q-H-Q configuration). Full control over each element is provided and user settings can be saved and recalled as presets.



Figure 1 – MAP-300 Manual polarization control GUI

Scrambling

Six predefined scrambling patterns are provided as well as one user definable mode. Scrambling modes are differentiated by three outcomes; the rate at which the SOP changes, the distribution of angle changes (as viewed on the Poincare sphere) and finally the coverage of the Poincare sphere.

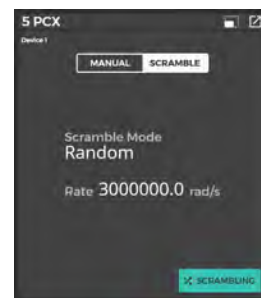

Figure 2 – MAP-300 Scrambling polarization control GUI

An intuitive graphic user interface (GUI) is optimized for use in either a laboratory or a manufacturing environment. Efficient transition between summary and detailed views (figure 3 and figure 4) allow users to operate at a system level or access the full power of a module.

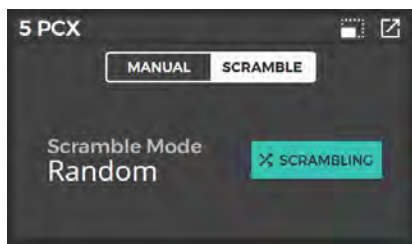

Figure 3 – mPCX MAP-300 summary view GUI

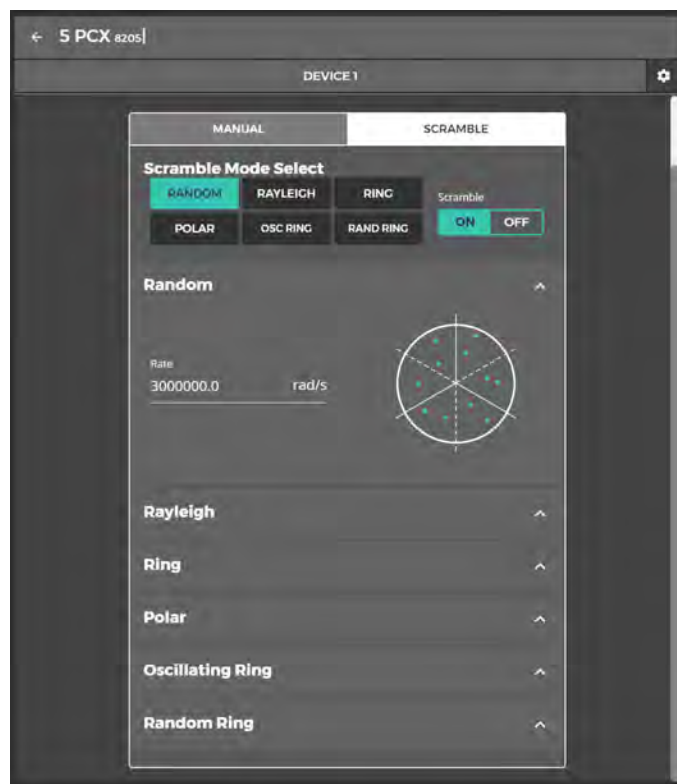

Figure 4 – mPCX MAP-300 detailed view GUI

SOP Feedback Option

SOP Feedback is the option that enables monitoring of the output state of polarization. While not a full polarimeter, several key features are enabled in a very cost effective manner.

Automated Ring Alignment

A great circle through the equator is a unique and powerful scrambling mode. It does however require a very specific input polarization state. With SOP Feedback enabled, the mPCX-C1 automatically adjusts itself to ensure this pattern is achieved with no manual intervention or external feedback.

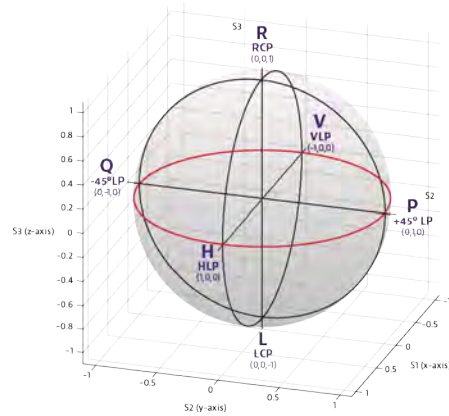

State Tracking and Return

Holding or returning to a specific SOP is also enabled. This can be very powerful when test cases require alternating between a specific SOP and scrambling or when longer term testing is required and drift of the SOP is not desirable.

Drift (Uncontrolled)

Drift (Stabilized)

60 min

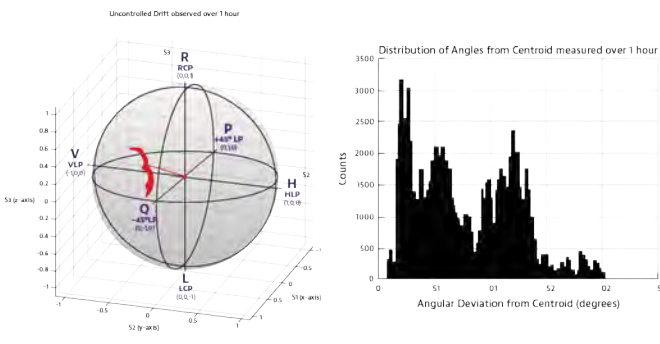

60 min

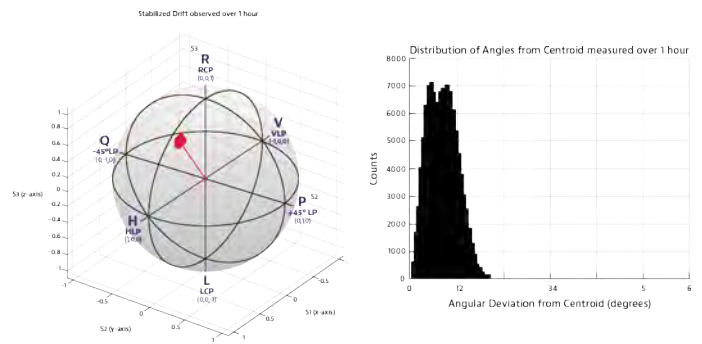

With the stabilization mode enabled, a tagged SOP can be held

Scrambling Dynamics

The mPCX-C1 has six pre-defined scrambling patterns available and one user defined mode. These patterns allow the user to tailor the level of complexity of the scrambling. Scrambling complexity is a function of the rate distributions and sphere coverage.

Random

Random scrambling is characterized by uniform coverage of the Poincaré sphere. The continuous evolution of the SOP can generate change rates of up to 3 Mrad/s and as low as 1 rad/s. For applications requiring rapid depolarization, this mode will generate a DOP of <5% in less than 10 μ s.

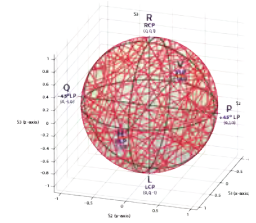

Rayleigh Distribution

This mode has full sphere coverage. The instantaneous rate of change follows a Rayleigh distribution which is biased towards lower rates but does occasionally have very high rates. This mode can be modified by changing the mean of the distribution. This pattern is often used for fiber emulation.

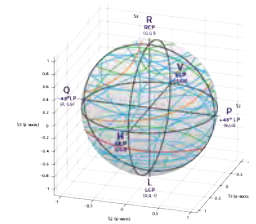

Ring (ideally used with SOP Feedback)

Ideal ring modes form great circles and orbit the Poincaré sphere. They generate a single constant Δ SOP frequency. For modules with SOP feedback, the ring trajectory can be auto-aligned to create a great circle pattern. Run open loop, the orientation of the ring will depend on the input SOP. This pattern is ideal for generating a depolarized signal with a constant Δ SOP signature.

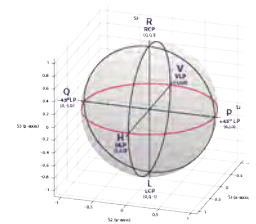

Polar Ring Pattern (ideally used with SOP Feedback)

Starting from an auto-aligned ring pattern, an additional rotational component can be added to create the Polar Ring Pattern. This pattern maintains a constant Δ SOP signature, but has the advantage of fully covering all states of polarization as the great circles rotate.

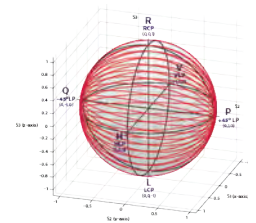

Oscillating Ring Pattern (ideally used with SOP Feedback)

The oscillating ring pattern adds a rate component to a ring to transition from north-pole to south-pole. This mode also has complete sphere coverage, but adds the additional complexity as the Δ SOP rate changes with the diameter of the orbit.

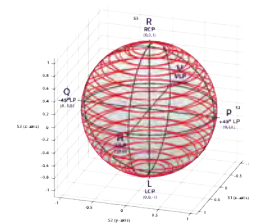

Random Ring Pattern

The random ring pattern is a combination of the polar ring and the oscillating ring. It is very similar to a full random pattern. This mode is ideal for test cases where the SOP rate distribution complexity is being increased incrementally from an aligned ring state.

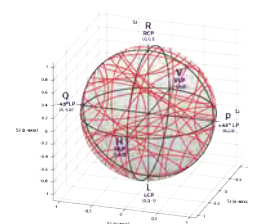

Discrete (User defined Scrambling)

User defined tables with up to 1000 entries can be created and stepped through. These selected states allow the user to create specific patterns.

Specifications

For more information on this or other products and their availability, please contact your local VIAVI account manager or VIAVI directly at 1-844-GO-VIAVI (1-844-468-4284) or to reach the VIAVI office nearest you, visit viavisolutions.com/contacts.

Specifications	C/L Band	O-Band	All Band
Basic Optical Specifications¹			
Wavelength range ²	1520 to 1620 nm	1265 to 1365 nm	1265 to 1620 nm
Maximum input power	+20 dBm		
Insertion Loss ³	≤ 3.0 dB no feedback, SMF ≤ 3.5 dB with feedback, SMF ≤ 3.5 dB no feedback, PMF ≤ 4.0 dB with feedback, PMF	≤ 3.5 dB no feedback, SMF ≤ 4.0 dB with feedback, SMF ≤ 4.0 dB no feedback, PMF ≤ 4.5 dB with feedback, PMF	≤ 3.5 dB
Polarization dependent loss	≤ 0.2 dB	≤ 0.25 dB no feedback, SMF ≤ 0.30 dB with feedback, SMF ≤ 0.25 dB no feedback, PMF ≤ 0.30 dB with feedback, PMF	≤ 0.25 dB
Return Loss	≥ 40 dB		
Manual Waveplate Mode¹			
Control modes	[QWP + QWP] or [QWP + HWP + QWP]		N/A
Waveplate rotation	Continuous (reset-free)		N/A
Waveplate angle setting resolution	0.01 °		N/A
Maximum waveplate rotation frequency	40 kHz		N/A
Rotation frequency setting resolution	0.01 Hz		N/A
Scrambling Modes¹			
Random			
Maximum scrambling rate range (Poincaré-space)	1.0 rad/s to 3.0 Mrad/s		
Maximum scrambling rate resolution (Poincaré-space)	$\pm 1\%$ of most significant digit		
Rayleigh⁴			
Mode Scrambling rate range (Poincaré-space)	350 krad/s to 1.0 rad/s		N/A
Maximum scrambling rate resolution (Poincaré-space)	$\pm 1\%$ of most significant digit		N/A

Specifications	C/L Band	O-Band	All Band
Ring			
Ring Auto Align Time ^{5,6}	5s typical (with feedback only)		N/A
Half-waveplate rotational frequency rate range (Poincaré-space)	2.5 rad/s to 1 Mrad/s (with feedback only)		N/A
Half-waveplate rotational frequency range (Waveplate-space)	0.1 Hz to 40 kHz		N/A
Other supported ring modes	Oscillating, Random, Polar		N/A
Discrete (User Tables)			
Maximum table length	1000		N/A
Angle transition rate (Optical ΔSOP slew rate)	≤ 60 μs	≤ 60 μs	N/A
SOP-Tracking (only available with feedback)^{1,7}			
 Holding Accuracy (Typical Controlled Environment)⁸			
15 min. user defined SOP	≤ 5 ° (typical)	≤ 5 ° (typical)	N/A
15 min. mPCX determined fixed state	≤ 3 ° (typical)	≤ 3 ° (typical)	N/A
Response time to stabilize an input impulse ΔSOP ⁹	≤ 0.3 s (typical)	≤ 0.3 s (typical)	N/A
Maximum input signal ΔSOP rate ⁹	40 ° /s		N/A
Min / max input power range	-5 dBm to +20 dBm		N/A
Recall of user-defined SOP (QWP + QWP mode only)	100 ms		N/A
Environmental			
Warm up time	60 min.		
Operating Temperature	0°C to 50°C		
Storage Temperature	-30°C to 70°C		
Physical			
Size (W x H x D)	4.06 cm x 13.26 cm x 37.03 cm		
Weight (approximate)	0.95 kg (2.0 lbs)		
Other			
Recalibration Interval	2 years		
Warranty	3 years		

- Guaranteed over 13°C to 33°C
- CL-band calibration λ: 1550nm. O-band calibration λ: 1310nm. All-band calibration λ: 1550nm
- Excludes the loss from one optical connector
- Parameters specified as the mode, σ, of the Rayleigh distribution, where $R(f,\sigma) = (f/\sigma^2) * \exp(-1/2) / (f/\sigma)^2$
- Large SOP excursions may require a two-step process to ensure original position is maintained
- Software overhead not included
- Requires stable optical power
- 25°C ± 3°C, normal fiber management on benchtop
- During continuous ΔSOP variation momentary excursions from target are expected. 90% of the time excursions from target will be less than 20° during dynamic measurements. Once the input variation ceases the control loop will re-acquire the target within 0.3s (typical)

Ordering Information

For more information on this or other products and their availability, please contact your local VIAVI account manager or VIAVI directly at 1-844-GO-VIAVI (1-844-468-4284) or to reach the VIAVI office nearest you, visit viasolutions.com/contacts.

The XX code defines the fiber type, as seen in table 1.

Part Number	Band	Description
MPCX-C11S0S-M100-Mxx	C/L-Band	SMF High-speed polarization scrambler/controller
MPCX-C11S0S-M103-MFA		PMF High-speed polarization scrambler/controller with FC/APC Connector
MPCX-C11SF5-M100-Mxx		SMF High-speed polarization scrambler/controller with SOP Feedback Option
MPCX-C11SF5-M103-MFA		PMF High-speed polarization scrambler/controller with SOP Feedback Option with FC/APC Connector
MPCX-C11S03-M100-Mxx	O-Band	SMF High-speed polarization scrambler/controller
MPCX-C11S03-M103-MFA		PMF High-speed polarization scrambler/controller with FC/APC Connector
MPCX-C11SF3-M100-Mxx		SMF High-speed polarization scrambler/controller with SOP Feedback Option
MPCX-C11SF3-M103-MFA		PMF High-speed polarization scrambler/controller with SOP Feedback Option with FC/APC Connector
MPCX-C11SBA-M100-Mxx	All-Band	Basic all-band High-speed polarization scrambler/controller

Table 1

XX Code	Connector Type
MFP	FC/PC
MFA	FC/APC
MSC	SC/PC
MSU	SC/APC

Optical Signal Switching and Routing

VIAVI Solutions, with its the JDS Uniphase legacy, is the pioneer in fiber optic switches and offers a diverse and innovative switch product line. The line includes 1 X N and 2 X N fiber optic switch modules, benchtop and rackmount programmable switches and M X N matrix switches. The full product line is available in single-mode and multimode with specific fiber variants customizable.

The performance, configuration and flexibility of VIAVI switches makes them suitable for a wide range of applications including fiber optic component testing, remote fiber system testing in telecommunication networks, transmitter/receiver measurements, reconfiguration and restoration and research and development. An Optical switch increase throughput and parallel processing through simultaneous testing of multiple parameters of one or more devices without repeated physical reconnection. This subcutaneously increase test equipment utilization and reduces test time, thereby reducing the cost of ownership of test equipment.



Optical Switch Solutions (mOSW-C1/mISW-C1)

MAP Series Optical Switch Solutions

Manufacturing test automation is critical to reducing product costs and optical switches are at the heart of any automated test system. The VIAVI Solutions mOSW-C1 Optical Switch Module and mISW Optical Switch Tray are built on the industry-leading, fourth-generation instrumentation class of VIAVI optical switch technology. With more than 30 years of leadership in optical switching across network, monitoring, and manufacturing applications, the mOSW-C1/mISW-C1 represents a new milestone for performance and reliability with the industry's smallest footprint.



For the first time, the performance and repeatability found in large, fixed format 19-inch VIAVI rack-mount systems are available in a modular plug-in or tray. Manufacturing engineers no longer have to choose between test system's size and its performance. Leveraging the mOSW-C1/mISW-C1 can reduce the size of switching systems by as much as 75% while still delivering the performance of much larger legacy systems. A 50% increase in switching speeds significantly saves testing time for connection-intensive architectures.

These switches are components of the MAP series family. With the widest range of optical modules in the industry, it is the most popular choice for manufacturing test automation across all optical industry segments. This includes the manufacture of passive components, transponders, and line cards. Advanced connectivity through remote VNC, Ethernet, GPIB, or local GUI makes the MAP series a natural choice for complex automation architectures because it dramatically simplifies debugging for remotely located manufacturing sites.

Key Benefits

- Provides all optical switching independently of data rate and transmission format
- Delivers minimal impact on system dynamic range regardless of switch size with low loss for all configurations from 1x2 to 1x176
- Flexible SCPI remote interface lets users program the switch using either MAP series style commands or maintain backward compatibility to the industry-standard VIAVI SB/SC series optical switches
- Guarantees ultra-low 0.04 dB PDL and ± 0.005 dB repeatability to minimize measurement uncertainties on single-input versions
- New PTRIM option measures in-line power and adds up to 20 dB of coarse programmable loss on a connected port
- 1C, 2D (duplex), 2E (dual input in each channel) and 2X (2x2 crossover) input configurations enable cost-saving architectures that reduce the number of switches required
- Expanded beam technology ensures multimode switches are "modally transparent" and do not disturb mode distributions, greatly simplifying transmission testing or testing with IEC-complaint mode launches

Applications

- Test system automation for multi-port components, modules, and line cards
- Manage complex manufacturing test sequencing
- Test for long-term reliability
- Paired with the MAP series mORL-A1 module to test multifiber connectors

Safety

- When installed in a MAP series chassis, MAP optical switches comply with CE, CSA/UL/IEC61010-1, and LXI Class C requirements.

Optical Performance

Switch Performance Improves Test Yield

Engineers developing automated test systems must consider the impact of the optical switch on the performance of the system under development.

To account for test uncertainties, the user must tighten the internal specification to ensure devices do not falsely pass. The necessary outcome is that a percentage of units are rejected, which could have been shipped to generate revenue. Test yield is defined as the percentage of devices that pass the internal specification relative to number of units that pass the external specification. These units are represented in zone B in Figure 1. The switch insertion loss (IL), polarization-dependent loss (PDL), repeatability, and stability all contribute to additional uncertainties in automated test systems. Selecting the mOSW-C1/mISW-C1 will minimize the switch impact on test yield, in many cases to unmeasurable levels.

Beware of switch solutions that are characterized using "typical" values and statistical performance. The VIAVI mOSW-C1/mISW-C1 can guarantee "better-than" performance levels and provides test reports to prove it. Test system designers no longer have to speculate about potential worst-case impact. Unlike many competitors, mOSW-C1/mISW-C1 switches are never cascaded to create large channel counts. IL, PDL, and repeatability are the same, regardless of switch size, and deliver a true loss of 0.7 dB, greatly simplifying dynamic range impact calculations.

With 30+ years of history delivering the industry's most repeatable switches, test engineers can be confident that the mOSW-C1/mISW-C1 will continue to perform to achievable limits.

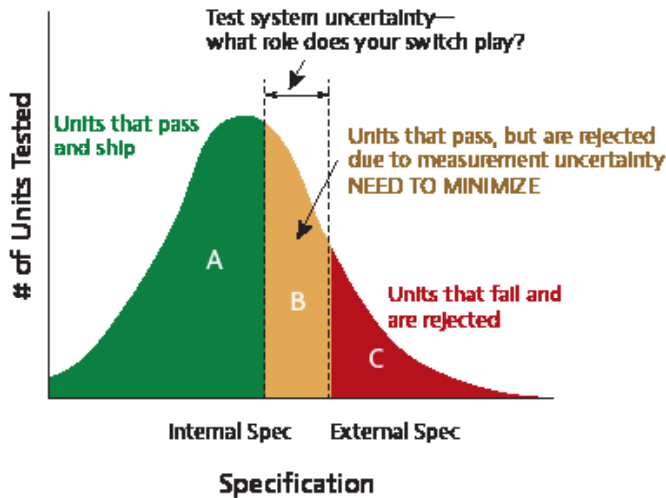

Figure 1. Measurement impact

For Both Single-Mode and Multimode Applications

The mOSW is available in single-mode (SM) and both standard multimode (MM) fiber types, OM1 (62.5 μm core) and OM3 (50 μm core), with specific design considerations built in for each type.

Unlike micro electro-mechanical system (MEMS) designs that use reflective switching techniques, the expanded VIAVI beam design operates at the limit of polarization-dependent loss performance with virtually no wavelength-dependent loss.

mISW in MAP-204c



With the growth in data center and storage applications, multimode performance is a paramount concern for manufacturers. Modal-transparency, a term coined by VIAVI in 2003, describes the interaction of the optical switch with the various transmitted optical modes. A switch that is modally transparent ensures that the entering mode profile remains undisturbed as it traverses the switch. This minimizes any spurious optical impairment during transmission tests where mode clipping or scattering into high-order modes can degrade BER performance. For IL testing applications, the mOSW-C1/mISW-C1 preserves the stringent IEC-specified launch conditions. Switch insertion loss is specified using IEC launch conditions to guarantee that it is the most reproducible switch device on the market.

Switching Time

Switching time can be separated into two key components. The first switching phase is the pure electro-mechanical time it takes to switch a connection (from break to make). The second switching phase is the settling time which is the time it takes to reach a stable insertion loss performing to the full level of the specification. Test designers who skip this second timing component are increasing their measurement uncertainty.

VIAVI has carefully optimized the mOSW-C1/mISW-C1 to achieve the fastest possible switching time and still meet the requirements for optical performance. Through characterization of the settling dynamics, VIAVI has designed the only switch on the market that details the stabilization timing. Knowing this, test engineers can confidently determine when to take measurements and how best to optimize measurement performance.

Power Trim Option (PTRIM)

Power Trim is a new option available for single-mode 1C versions with fewer than 80 ports that offers two new capabilities to simplify integration and remote troubleshooting, as shown in the examples in Figures 2 and 3.

Bidirectional Power Monitor

Optical power is displayed on the graphical user interface (GUI) next to the common port (Port 1) and indicates the transmission direction. The bidirectional power monitor automatically senses the use of the common port as input or output. In-line power monitors can greatly simplify remote troubleshooting in distant factories. Test engineers can remotely log in to the MAP chassis to verify the accuracy of power levels for any particular connected test path.

Loss Trimming

Users can increase the insertion loss for the connected optical path by up to 20 dB using a programmable Trim Index. The trimming function simplifies setting power levels without requiring exact precision. For example, level setting a signal into a receiver port during system test or bringing a laser signal out of the saturation region.

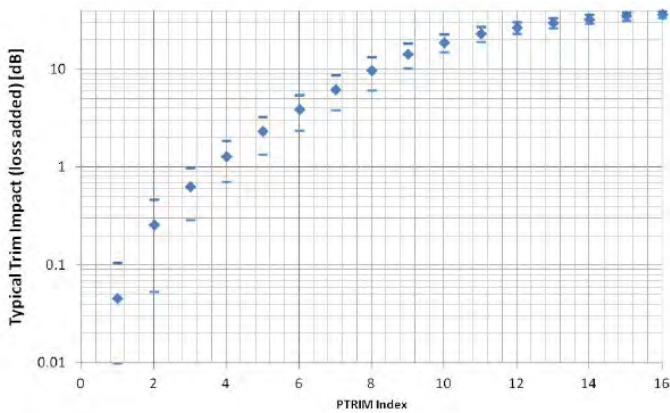

Figure 2. Typical PTRIM impact for 1CxN with 24 ports or fewer

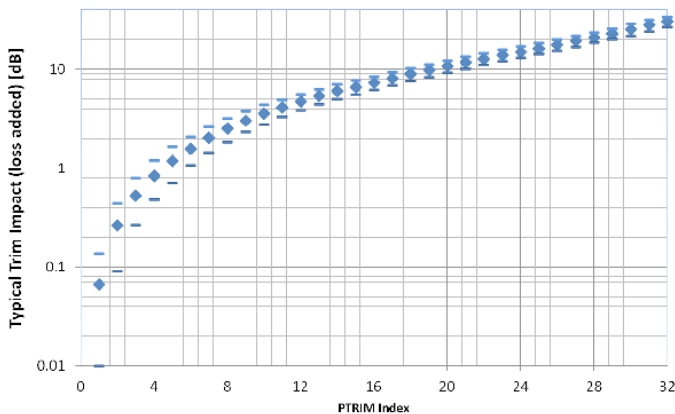

Figure 3. Typical PTRIM impact for 1CxN with more than 24 ports and fewer than 80 ports

Configurations that Reduce Cost

Size and Flexibility

The MAP series offers a large array of switch sizes and packaging options. The mOSW-C1 is optimized for smaller 1x2, 2x2, and up to 1x24 channel counts. Configuration selection will determine whether a single or dual-slot module is delivered, and modules are available in pigtail and bulkhead connector versions, as shown in Figure 4.



Figure 4. Single-width and dual-width modules with bulkhead followed by single-width and dual-width module with pigtail exits

Running the mOSW requires a MAP-200 or MAP-300 chassis, available in 2- (only in the MAP-200 series), 3-, or 8-slot rack-mounted or benchtop versions similar to the one shown in Figure 5.



Figure 5. An mOSW-C1 mounted in a MAP-220C.

Similar choices are available for the mISW-C1 switch tray. As Figure 6a and 6b shows, for fewer than 76 channel counts, the optical switch tray is delivered in a MAP-202C. The larger 4U MAP-204C accommodates up to 176 switch outputs. The chassis must be selected as part of the tray configuration. These systems are not modular; the tray is mounted in the chassis at the factory. Access is available, but only for service.

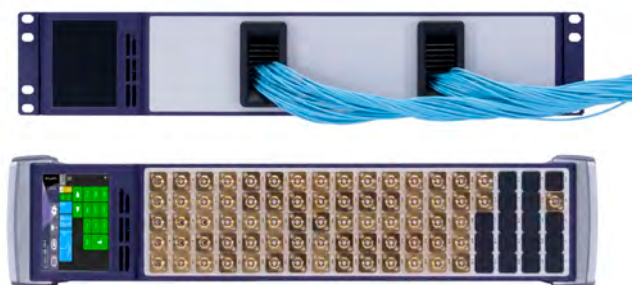

Figure 6a. A 2 RU MAP-202C with a bulkhead or pigtail.



Figure 6b. A 4U MAP-204C can be used for switches with more than 76 output ports.

Compact Design

The MAP series chassis are the most compact optical test platform on the market today with designs that are often 75 percent smaller than traditional optical test equipment. Compact designs reduce production costs because they reduce the raw materials needed, reduce the number of mainframes required, and save space overall.

The compact form factor of the VIAVI optical switch technology allows for packaging multiple independent switches in to a single MAP module. For example, up to eight 1x2 modules can be packaged in a single-slot module, enabling sixty-four 1x2 switches in only 3U of 19-inch rack height. Alternatively, up to sixteen 1x4 modules can be packaged in the same space.

Minimizing the number of modules also saves on overall rack-system space, moving automated test systems from two bays to one. In a modern contract-manufacturing scenario, single-bay test systems are less costly to ship, easier to deploy, and require half the floor space.

Leveraging Switch Type (1C, 2D, 2E, 2X)

To simplify test system integration, the mOSW-C1/mISW-C1 supports three unique input types, shown in Figure 7:

- Standard single common input (1C type)
- Duplex input (2D type)
- Dual parallel input (2E type)
- Dual parallel or crossover input to output (2X type)

The D and E types are commonly referred to as “ganged” input switches. The relative positions of the A and B inputs are locked and cannot be changed. However, leveraging these multiple connected paths can potentially save costs.

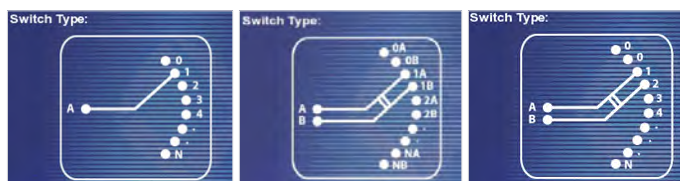

Figure 7. Single common (1C type), duplex (2D type), and dual parallel (2E type)

The duplex configuration is most powerful when test systems have well defined transmit (Tx) and receive (Rx) paths. As Figure 8 shows, one 2Dx4 can replace two 1Cx4 switches. Removing one switch reduces the relative test system costs, saving module space and greatly simplifying test sequencing (requiring only one command to select the Tx/Rx port under test). The advantage of using a 2E version is that it allows both A and B inputs to access all outputs; therefore, the 2E could be deployed as either a 2D or a 1C, depending on testing needs.

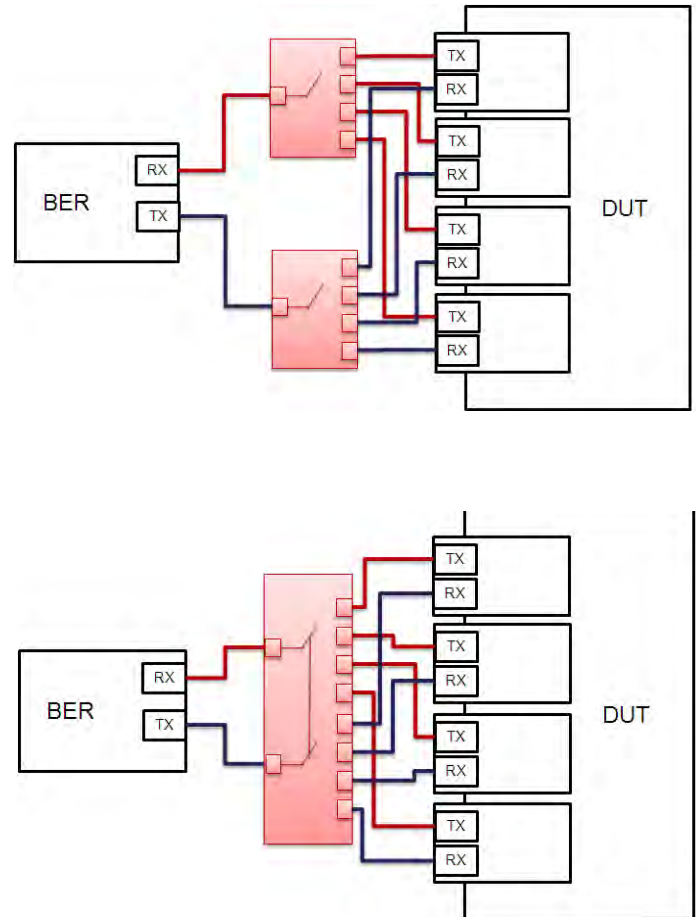

Figure 8. Converting a two 1Cx4 system to a single 2Dx4 system

Enhanced GUI and Labeling

While the majority of applications for the mOSW-C1/mISW-C1 will leverage the remote interface (which is backwards-compatible to the legacy mLCS-A1/A2), VIAVI has also simplified the module for manual use. As Figure 9 shows, product labels are bright, high contrast, and easy to read. Latch labels clearly identify the fiber and connector type. Units with the pigtail option have 2 meter pigtails and use standardized fiber color-coding to identify the fiber type.



Figure 9. Dual-slot bulkhead switch

The revitalized GUI, shown in Figures 10a and 10b, has several simple powerful features for easier use. The novel “hover and release” channel selection lets users clearly see what port connection will be made, prior to selecting it. It clearly communicates the A and B paths at all times. A simple toggle interface is provided for 1x2 and 2x2 switches with only two states. In the detailed views, schematic diagrams of the switch type clearly communicate the topology of the switch type (1C, 2D, 2E) to eliminate guesswork during troubleshooting. A programmable connection table lets users identify which equipment is connected to which port, simplifying troubleshooting.



Figure 10b. Detailed mOSW-C1 screen

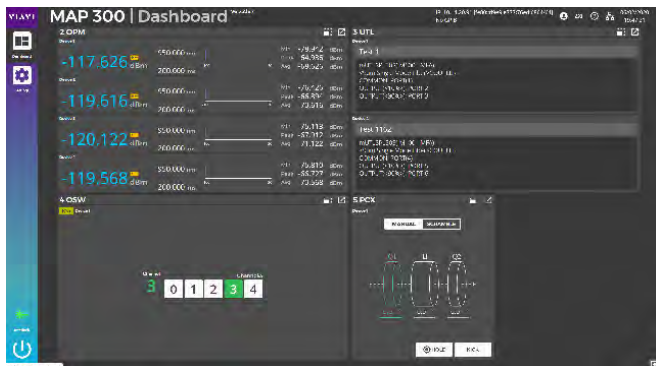

Figure 10a. Multimodule view of the MAP series GUI

Specifications

Optical and Environmental

mISW-C1, mOSW 1x4 Configurations and Larger

Parameter ¹	1C Configuration	2D Configuration	2E Configuration
Wavelength range			
Single-mode ² (SM)	1250 to 1650 nm		
Multimode ³ (MM)	760 to 1360 nm		
Insertion loss (IL)⁴			
Single-mode (SM)	0.7 dB	0.7 dB	0.9 dB
Multimode (MM)	0.9 dB	0.9 dB	1.0 dB
Return loss (RL)⁵			
Single-mode (SM)	62 dB	62 dB	60 dB
Multimode (MM), OM1 (62.5 μm)	30 dB	30 dB	25 dB
Multimode (MM), OM3 (50 μm)	40 dB	40 dB	35 dB
Polarization-dependent loss (PDL)⁶			
	0.04 dB	0.05 dB	0.07 dB
Repeatability⁷			
Sequential switching	±0.005 dB	±0.01 dB	±0.01 dB
Random switching	±0.025 dB	±0.04 dB	±0.04 dB
IL stability⁸ (maximum)			
	±0.025 dB		
Crosstalk (maximum)			
Single-mode (SM)	-80 dB		
Multimode (MM)	-60 dB		
Max input power (optical)			
	300 mW		
Lifetime			
	100 million switching cycles		
Switching time			
	≤ 24 ports	>24 ports < 72	>72 ports
Electro-mechanical (break to make)	20+10*(N-1) ms	55+30*(N-1) ms	35+11*(N-1) ms
Settling time to 90% final IL	60 ms	70 ms	90 ms
Settling time for 99% final IL	90 ms	120 ms	200 ms
Operation temperature			
	0 to 50°C		
Operation humidity			
	15 to 80% RH, 0 to 40°C noncondensing		
Storage temperature			
	-30 to 60°C		
Power trim option for single-mode⁹			
	1CxN9 with <72 ports		
Additional IL	0.6 dB		
Return loss	55 dB		
Additional through path PDL	0.02 dB		
Power measurement range	+10 to -55 dBm (1550 nm)		
Power trim range	20 dB (typical)		
Power trim index	0 to 16 (≤ 24 ports); 0 to 32 (>24 ports) (typical trim resolution shown below)		

*All specifications are presented for PTRIM index set to zero.

Notes:

- All optical measurements excluding connectors, taken after temperature has been stabilized for minimum of one hour, at ambient room temperature between 20–30°C and variation less than ±3°C
- For IEC 60793-2-50 Type B1.3/ISO 11801 OS2 compliant fiber, such as Corning SMF-28e
- For OM1 and OM3 fiber type compliant with ISO/IEC 11801
- Excluding connectors; tested at 1310 and 1650 nm for SM and 850 and 1300 nm for MM with IEC 62614 ED1.0 2010-compliant EF
- RL excluding the connectors with 2m pigtail length; tested at 1310/1625 nm for SM and 850/1300 nm for MM IEC 62614 ED1.0 2010-compliant EF
- PDL tested at 1310 and 1650 nm
- Measured between two consecutive readings over 100 cycles
- Any channel drift relative to reference channel at ±3°C deviation of ambient temperature over a 7-day period (168 hours)
- Typical power trim curve is characterized at 1550 nm for reference purposes only; actual performance could vary based on the channel and wavelength being operated

Specifications

Optical and Environmental

mOSW-C1,1x2 and 2x2

Parameter ¹	1x2	2x2
Wavelength range		
Single-mode ² (SM)	1290 to 1330 nm and 1520 to 1650 nm	
Multimode ³ (MM)	760 to 1360 nm	
Insertion loss (IL)⁴		
Single-mode (SM)	0.7 dB	1.2 dB
Multimode (MM)	0.9 dB	1.2 dB
Return loss (RL)⁵		
Single-mode (SM)	50 dB	50 dB
Multimode (MM), OM1 (62.5 μm)	30 dB	25 dB
Multimode (MM), OM3 (50 μm)	40 dB	35 dB
Polarization-dependent loss (PDL)⁶		
	0.07 dB	0.08 dB
Repeatability⁷		
	±0.02 dB	±0.03 dB
IL stability⁸(maximum)		
		±0.025 dB
Crosstalk (maximum)		
Single-mode (SM)	-55 dB	
Multimode (MM)	-55 dB	
Max input power (optical)		
	300 mW	
Lifetime		
	100 million switching cycles	
Switching time		
	Single-Mode	Multimode
Electro-mechanical (break to make)	4 ms	210 ms
Settling time for 90% final IL	2 ms	60 ms
Settling time for 99% final IL	4 ms	90 ms
Operation temperature		
	0 to 50°C	
Operation humidity		
	15 to 80% RH, 0 to 40°C noncondensing	
Storage temperature and humidity		
	-30 to 60°C noncondensing	

- Notes:
1. All optical measurements, excluding connectors, taken after temperature has been stabilized for minimum of one hour, at ambient room temperature between 20 to 30°C with a variation of less than ±3°C.
 2. For IEC 60793-2-50 Type B1.3/ ISO 11801 OS2 compliant fiber (for example, Corning SMF-28e).
 3. For fiber type of OM1 and OM3 fiber compliant with ISO/IEC 11801.
 4. Excluding connectors. Tested at 1310 and 1650 nm for SM and 850 and 1300 nm for MM with EF compliant with IEC 62614 ED1.0 2010.
 5. RL excluding the connectors with 2 m pigtail length. Tested at 1310 and 1625 nm for SM and 850 and 1300 nm for MM with EF compliant with IEC 62614 ED1.0 2010.
 6. PDL tested at 1310 and 1650 nm.
 7. Measured between two consecutive readings over 100 cycles.
 8. Drift of any channel relative to reference channel at ±3°C deviation of ambient temperature over a 7-day period (168 hours).

Specifications

Packaging

General		mOSW	
Dimensions (W x H x D)			
Single slot	4.1 x 13.3 x 37.0 cm (1.6 x 5.2 x 14.6 in)		
Dual slot	8.1 x 13.3 x 37.0 cm (3.2 x 5.2 x 14.6 in)		
Weight			
Single slot with pigtails	1.75 kg (3.14 lb)		
Dual slot with pigtails	3.1 kg (6.14 lb)		
Pigtail length on units with pigtails	2 m		
General		mISW	
	MAP-202C, 2U (< 72 ports)	MAP-204C, 4U (> 72 ports)	
Dimensions (W x H x D)	444 x 88.2 x 386.5 mm (17.5 x 3.5 x 15.2 in)	444 x 177 x 386.5 mm (17.5 x 7 x 15.2 in)	
Weight	13 kg (28.7 lb)	20 kg (44.1 lb)	

MAP Optical Switch Solutions

mISW-C1

The mISW-C1 Optical Switch module is the industry standard for manufacturing test automation applications and has the widest array of switch options in the industry. A member of the LightDirect Family of MAP-200 modules the mISW-C1 is optimized for switch configurations with more than 24 channels.

The 2U MAP-202C chassis is required for channel counts from 24 to 72.
 The 4U MAP-204C chassis is required for channel counts from 96 to 176.

Configuration Process

All mISW switches are configured by a single part number that defines the function and options of the switch.

The structure of the part number mISW-C1**ABBCCDE**-**MXXX**-**MY** is as follows:

- A** refers to the number of independent mOSW-C1 switches in the module (currently only 1)
- BB** refers to the switch type and defines the input type (1C, 2D¹, 2E)
- CCC** defines the number of outputs (from 024 to 176, increments shown in table)
- D** defines the termination type (B for bulkhead, Q for 3m pigtails, R for 10m pigtails).
- E** defines the options (0 = no option, 1 = Power Trim option²)
- MXXX** defines the fiber type, refer to Table 1
- MY** defines the connector type, refer to Table 2



4U MAP-204CXR-A

Table 1

Code	Fibre Type
M100	9µm Single Mode
M101	50µm (OM3)
M102	62.5µm (OM1)
M105 ³	100µm

Table 2

Code	Connector Type
MFA	FC/PC
MFP	FC/APC
MSC	SC/PC
MSU	SC/APC
MLC	LC/PC
MLU	LC/APC

Notes

1. D Config part numbers indicate the number of switchable output states. The total number of physical output connectors will be 2X the number of states i.e. 2DX024 has 48 output connectors
2. Power Trim option is available only for single mode 1C type switch with <=72 ports
3. 100µm fiber type is available only for FC bulkhead termination with <=72 ports



Available Configurations

MISW-C1, 24 to 72 outputs

Number of Switches	Input Type	Connectivity	Switch Fabric	Part Number
One switch per module	1C (Single Input)	Bulkhead	1Cx24	MISW-C111C024BE-MXXX-MYY
			1Cx32	MISW-C111C032BE-MXXX-MYY
			1Cx48	MISW-C111C048BE-MXXX-MYY
			1Cx72	MISW-C111C072BE-MXXX-MYY
		3m Pigtail	1Cx32	MISW-C111C032QE-MXXX-MYY
			1Cx48	MISW-C111C048QE-MXXX-MYY
			1Cx72	MISW-C111C072QE-MXXX-MYY
		10m Pigtail	1Cx48	MISW-C111C048RE-MXXX-MYY
			1Cx72	MISW-C111C072RE-MXXX-MYY
		2D (Duplex)	Bulkhead	2Dx12
	2Dx16			MISW-C112D016B0-MXXX-MYY
	2Dx24			MISW-C112D024B0-MXXX-MYY
	2Dx36			MISW-C112D036B0-MXXX-MYY
	3m Pigtail		2Dx16	MISW-C112D016Q0-MXXX-MYY
			2Dx24	MISW-C112D024Q0-MXXX-MYY
			2Dx36	MISW-C112D036Q0-MXXX-MYY
	10m Pigtail		2Dx24	MISW-C112D024R0-MXXX-MYY
			2Dx36	MISW-C112D036R0-MXXX-MYY
	2E (Dual input, every channel)		Bulkhead	2Dx24
		2Dx32		MISW-C112E032B0-MXXX-MYY
		2Ex48		MISW-C112E048B0-MXXX-MYY
		2Ex72		MISW-C112E072B0-MXXX-MYY
		3m Pigtail	2Ex32	MISW-C112E032Q0-MXXX-MYY
			2Ex48	MISW-C112E048Q0-MXXX-MYY
			2Ex72	MISW-C112E072Q0-MXXX-MYY
		10m Pigtail	2Ex48	MISW-C112E048R0-MXXX-MYY
			2Ex72	MISW-C112E072R0-MXXX-MYY

Select the required options for E, fiber type XXX & connector type YY

Mandatory Chassis for the Modules Above (<= 72 output ports)

Description	Part Number
MAP-202C LightDirect, 2 U, 19-in, bench-top chassis	MAP-202C-A
MAP-202C LightDirect, 2 U, 19-in, rack-mount chassis	MAP-202CX-A
MAP-202C LightDirect, 2 U, 19-in, reverse rack-mount chassis	MAP-202CXR-A

Available Configurations Continued

MISW-C1, 96 to 176 outputs

Number of Switches	Input Type	Connectivity	Switch Fabric	Part Number
One switch per module	1C (Single Input)	Bulkhead	1Cx96	MISW-C111C096B0-MXXX-MYY
			1Cx136	MISW-C111C136B0-MXXX-MYY
			1Cx176	MISW-C111C176B0-MXXX-MYY
		3m Pigtail	1Cx136	MISW-C111C136Q0-MXXX-MYY
			1Cx176	MISW-C111C176Q0-MXXX-MYY
			1Cx136	MISW-C111C136R0-MXXX-MYY
	2E (Dual input, every channel)	Bulkhead	1Cx96	MISW-C112E096B0-MXXX-MYY
			1Cx136	MISW-C112E136B0-MXXX-MYY
			1Cx176	MISW-C112E176B0-MXXX-MYY
		3m Pigtail	1Cx136	MISW-C112E136Q0-MXXX-MYY
			1Cx176	MISW-C112E176Q0-MXXX-MYY
			1Cx136	MISW-C112E136R0-MXXX-MYY
1Cx176	MISW-C112E176R0-MXXX-MYY			

Select the required options for E, fiber type XXX & connector type YY

Mandatory Chassis for the Modules Above (72 to 176 output ports)

Description	Part Number
MAP-204C LightDirect, 2 U, 19-in, rack-mount chassis	MAP-204CX-A
MAP-204C LightDirect, 2 U, 19-in, reverse rack-mount chassis	MAP-204CXR-A

mISW GPIB Options

Description	Part Number
MAP-200 GPIB plug-in option for 220C/202C/204C chassis	MAP-200CGPIB-A

Additional Test Reports for Single-Mode Versions

Description	Part Number
Bidirectional test report for single switch with 13 to 24 ports for use with mISW/MAP-202 chassis	MBIDTEST1-024
Bidirectional test report for single switch with 25 to 48 ports for use with mISW/MAP-202 chassis	MBIDTEST1-048
Bidirectional test report for single switch with 49 to 96 ports for use with mISW/MAP-202/204 chassis	MBIDTEST1-096
Bidirectional test report for single switch with 97 to 176 ports for use with mISW/MAP-204 chassis	MBIDTEST1-176

Replacement Parts

Description	Part Number
MAP-220C LightDirect controller replacement	MAP-200CLD-A
MAP-200 rack-mount kit for 220C/202C/204C chassis	MAP-200C01
MAP-200 bench-top kit for 220C/202C/204C chassis	MAP-200C02
Capacitive stylus for MAP-200 controller	MAP-200A18

© 2020 VIAVI Solutions Inc.
 Product specifications and descriptions in this document are subject to change without notice.
 mapisw-sg-lab-nse-ae
 30175797 900 0617

Passive Utility Module (mUTL-C1)

Simplified Component Test Management for MAP Series

The Multiple Application Platform (MAP series) Passive Utility Module, mUTL-C1, is designed to simplify the mechanical integration of passive optical components into large automated test systems and removes the “stray” optical components that are loose and often damaged during operation or transport. It is optimized for the industry-leading VIAVI Solutions MAP series platform



The mUTL-C1 cassettes simplifies the mechanical integration of passive optical components for test sets. They are highly configurable, contain passive optical devices such as splitters and taps. They support angle or flat polished connectors as well as single-mode and multi-mode fibers. Each module has user definable data fields that can be accessed by the MAP series chassis to assist in module identification and displayed or recalled remotely.

Options and Configurations

A wide range of standard components are available:

- A range of single-mode and multimode optical couplers enabling power reference paths or tapping signals for in-line test. They are orderable with any of six types of optical connectors.
- 40G and 100G Ethernet standards have adopted WDM technology for single fiber interfaces. The mUTL-C1 provides Mux/Demux modules complying with the IEEE standards and are the ideal solution to isolate individual lanes for test access.
- LAN-WDM multiplexers to multiplex and de-multiplex 8 LAN-WDM channels as according to 400GBASE LR8/ FR8 supporting IEEE 802.3bs standard.

Features and Benefits

- Mechanically robust integration of fiber optic couplers, splitters and mux/demux components into larger integrated test environments
- Compact design with 12 bulkhead connectors enables packaging of up to four 3-port couplers
- Bulkhead only versions available for mounting user supplied components
- Single-mode or multimode component options.
- Multimode components are modally transparent
- Ideal for individual lane testing of WDM signals for next generation Ethernet formats such as 100/200/400GE

Applications

- In-line tapping of signals for power and spectrum measurements
- Power reference branches for passive component test
- Splitting signals for parallel test applications
- Bit error rate test (BER)
- Passive component test
- Optical amplifier test

Safety Information

- Complies with CE, CSA/UL/IEC61010-1, plus LXI class C requirements when installed in a MAP chassis

- A quad wavelength filter for shaping ASE spectrum or reducing ASE in the standard 1310 / 1490 / 1550 / 1625 nm test windows.
- A bulkhead-adapters only module is also available for mechanical mounting of user supplied components. These cassettes are supplied with mounting hardware and twelve bulkhead adapters for ease of integration of up to four 3-port devices

Specifications

Device	Parameter	Specifications
100GE MUX/DMUX	Fiber Type	Single-Mode
	Center Wavelength	1295.6, 1300.1, 1304.6, 1309.1 nm
	Insertion Loss (IL)	< 2.0 dB
	Pass Bandwidth	± 1.50 nm
	Ripple in Pass Bandwidth	< 0.5 dB
	Return Loss	> 45 dB
	Isolation Adjacent Channel	> 15 dB
	Isolation Non-adjacent Channel	> 15 dB
40GE MUX/DMUX	Fiber Type	Single-Mode
	Center Wavelength	1271, 1291, 1311, 1331 nm
	Insertion Loss (IL)	< 1.7 dB
	Pass Bandwidth	± 6.50 nm
	Ripple in Pass Bandwidth	< 0.5 dB
	Return Loss	> 45 dB
	Isolation Adjacent Channel	> 30 dB
	Isolation Non-adjacent Channel	> 50 dB
LR8 MUX/DMUX	Fiber Type	SMF-28 compatible core 9 / 125 / 250µm with 900µm loose tube
	Center Wavelength	1273.55, 1277.89, 1282.26, 1286.66, 1295.56, 1300.05, 1304.58, 1309.14 nm
	Insertion Loss (IL)	< 3.4 dB
	Pass Bandwidth	± 2.1 nm
	Return Loss	> 45 dB
	Isolation Adjacent Channel	> 25 dB
	Isolation Non-adjacent Channel	> 35 dB
	Directivity	> 50 dB
	PDL	< 0.5 dB
Source Shape and ASE Filter	Fiber Type	Single-Mode
	Wavelength	1310, 1490, 1550, 1624 nm
	Bandwidth	± 6.50 nm
	Insertion Loss (IL)	< 1.5 dB
	Return Loss	> 45 dB

Specifications continued

Device	Parameter	Specifications
Single-Mode Coupler	Fiber Type	Single-Mode 9/125 μm
	Wavelength	1310/1550 nm
	Optical Power Handling	300 mW
	Coupler Type	10% / 90% 30% / 70% 50% / 50% 1 x 8 splitter
	Insertion Loss	10% < 11.8 dB 30% < 6.5 dB < 4.1 dB < 11.5 dB 90% < 1.2 dB 70% < 2.4 dB
	PDL	10% < 0.1 dB 30% < 0.1 dB < 0.05 dB < 0.3 dB 90% < 0.07 dB 70% < 0.07 dB
	Return Loss	≥ 45 dB
Multimode Coupler	Fiber Type	Multimode 50/125 μm
	Wavelength	850/1310 nm
	Optical Power Handling	300 mW
	Coupler Type	10% / 90% 50% / 50%
	Insertion Loss	10% < 11.8 dB < 4.1 dB 90% < 1.2 dB
	Return Loss	≥ 25 dB
Single Mode Artifact for mSWS	Fiber Type	Single-Mode
	Insertion Loss (IL)	≤ 5.5 dB
	Return Loss	≥ 65 dB
Single Mode Artifact for PCT	Fiber Type	Single-Mode
	Insertion Loss (IL)	≤ 1.7 dB
	Return Loss	≥ 50 dB

Notes:

1. All optical measurements, excluding connectors, taken after temperature has been stabilized for minimum of one hour, at ambient room temperature between 20 to 30°C with a variation of less than ± 3 .

Common Parameters	Specifications
Maximum Bulkhead Connectors	12
Connector Types	FC/PC, FC/APC, SC/PC, SC/APC, LC/PC, LC/APC
Slot Width	1
Dimensions (W x H x D)	4.06 x 13.26 x 37.03 cm
Weight	1 kg
Operating Temperature	0 to 50
Operating Humidity	15 to 80% RH, 0 to 40 noncondensing
Storage Temperature and Humidity	-30 to 60 noncondensing

Ordering Information

For more information on this or other products and their availability, please contact your local VIAVI account manager or VIAVI directly at 1-844-GO-VIAVI (1-844-468-4284) or to reach the VIAVI office nearest you, visit viavisolutions.com/contacts.

All mUTL-C1 cassettes are configured by a single part number that defines the function and options of the module. The XX code defines the connector type, as seen in table 1.

Available Configurations

Category	Splitter Type	Part Number	Description
Connector Only	None	MUTL-C1000B-Mxx	12 bulkhead connectors for use with customer supplied components
Single-mode 9/125 μm Splitter Modules	10% / 90%	MUTL-C12000-M100-Mxx	Two 10/90 splitters
		MUTL-C14000-M100-Mxx	Four 10/90 splitters
	30% / 70%	MUTL-C10200-M100-Mxx	Two 30/70 splitters
		MUTL-C10400-M100-Mxx	Four 30/70 splitters
	50% / 50%	MUTL-C10020-M100-Mxx	Two 50/50 splitters
		MUTL-C10040-M100-Mxx	Four 50/50 splitters
	Combination	MUTL-C12020-M100-Mxx	Two 10/90 splitters and two 50/50 splitters
		MUTL-C10220-M100-Mxx	Two 30/70 splitters and two 50/50 splitters
		MUTL-C12200-M100-Mxx	Two 10/90 splitters and two 30/70 splitters
		MUTL-C11110-M100-Mxx	Single 10/90 splitters, single 30/70 splitter and single 50/50 splitters
	1 x 8	MUTL-C1SPL18-M100-Mxx	Single 1x8 splitter
Multimode 50/125μm Splitter Modules	10% / 90%	MUTL-C11000-M101-Mxx	Single 10/90 splitter, modally transparent
		MUTL-C12000-M101-Mxx	Two 10/90 splitter, modally transparent
		MUTL-C14000-M101-Mxx	Four 10/90 splitter, modally transparent
	50% / 50%	MUTL-C10010-M101-Mxx	Single 50/50 splitter, modally transparent
		MUTL-C10020-M101-Mxx	Two 50/50 splitter, modally transparent
		MUTL-C10040-M101-Mxx	Four 50/50 splitter, modally transparent
	Combination	MUTL-C11010-M101-Mxx	Single 10/90 splitter and single 50/50 splitters, modally transparent
		MUTL-C1200-M101-Mxx	Two 10/90 splitters and two 50/50 splitters, modally transparent

Ordering Information continued

Category	Part Number	Description
Specialty Modules	MUTL-C1040GE-M100-Mxx	40GE standard MUX/DEMUX, single-mode 9/125µm fiber
	MUTL-C1100GE-M100-Mxx	100GE standard MUX/DEMUX, single-mode 9/125µm fiber
	MUTL-C1LR8DMUX-M100-Mxx	LR8 standard MUX/DEMUX, single-mode 9/125µm fiber
	MUTL-C1SMART-M100-MFA	Verification Artifact for mORL PCT, single mode 9/125µm fiber with FC/APC connectors
	MUTL-C1SWSRL-M100-MFA	Return Loss Artifact for mSWS, single-mode 9/125µm fiber with FC/APC connectors
	MUTL-C1OCETS-M100-MFA	Dual coupler and reflector for mOCETS, single mode 9/125µm fiber with FC/APC connectors
	MUTL-C1OCETS-M101-MFA	Dual coupler and reflector for mOCETS, multimode 50/125µm fiber with FC/APC connectors
	MUTL-C1OCETS-M102-MFA	Dual coupler and reflector for mOCETS, multimode 62.5/125µm fiber with FC/APC connectors
	MUTL-C1SRCFLT-M100-MFA	Source shaping and ASE rejection filter 1310/1490/15/1625, single mode 9/125µm

Table 1 – Connector Option Code

XX Code	Connector Type
MFP	FC/PC
MFA	FC/APC
MSC ²	SC/PC
MSU ²	SC/APC
MLC	LC/PC
MLU	LC/APC

2. The SC connector option is only an external option and the connector internally is type FC (MFA or MFP)

Cross Connect Optical Switch (mOSX-C1)

Optical Matrix Switch for MAP Series

The MAP Series mOSX-C1 optical matrix switch is part of the broader VIAVI test automation switch portfolio. More than just a switch, the mOSX-C1 is a low loss, flexible test path manager. Connecting multiple test paths across the switch fabric enables parallel test processes and dramatically reduce the cost of test.



VIAVI Solutions is the world leader in 1xN optical switches for test and automation applications. For over 30 years VIAVI switches have been a key enabler of test automation strategies to reduce the cost of test. For the first time, cross connect optical switches are being offered as part of the MAP portfolio.

The switch fabric supports a unique any-port to any-port connection fabric and enables both symmetric MxM (for example 8x8), and asymmetric topologies (4x12 for example). This flexibility enables users to reconfigure

the switch on demand. Ports can be allocated as needed (input or output) and are not trapped with a connection that cannot be made. All connections may be pre-configured – without light present - and are in a blocking state prior to being activated. Connections can be made and broken without impact on any other connection.

The mOSX switch adds tremendous test sequence automation flexibility and reduces switch variant requirements across the manufacturing line. The same switch can be used to fill many roles. One switch type can be used in applications ranging from complex manufacturing test sequencing a single DUT, test systems having many independent DUT's or automation of multi-port components.

Benefits

- Increase capital utilization factors, enabling on demand, parallel test architectures
- Replace multi-layer switching architectures, reduces loss and reconfiguration times
- Minimize switching variant
- Drives deeper integration and reduces test set size

Features

- Non-blocking, bidirectional matrix switch
- Wide wavelength range, 1250 to 1675 nm
- 1.0 dB typical insertion loss
- 25ms switching speed
- Flexible SCPI remote interface or MAP Series Graphical User Interface (GUI)
- Connections between ports can be disabled or re-enabled

Applications

- Test system automation for multi-port components, modules and line cards
- Manage complex manufacturing test sequencing
- Can be paired with MAP-Series mOSW modules to create larger more complex switching systems

Safety Information

- When installed in a MAP chassis, MAP optical switches comply with CE, CSA/UL/IEC61010-1, and LXI Class C requirements.

When the mOSX is paired with the VIAVI mOSW, large complex switch solutions can be developed, thus minimizing switching costs.



Functional Description

The mOSX switch is a low insertion loss (< 1.0 dB typical and <1.5dB max), fast switching (< 25ms to full specification) and non-blocking matrix switch. The switching engine is based on extremely compact piezo electric actuators that are used to align the signal path using expanded beam optics. Diffraction limited optics connect fiber pairs and ensures industry leading optical performance. A capacitive sensor matrix measures the position of the collimating lens to nanometer accuracy and ensures long term stability and repeatability. Connections are maintained even if light is not present. The simple optical path enables very low PDL and minimizes return loss.

Reflective optics “fold” the switch engine, allowing each fiber to connect to all other fibers. Thus, providing a flexible switch configuration with the same hardware dynamically set up by software. A 16-port switch can be a dual 4x4, 8x8, 7x9, 6x10...or 1x15

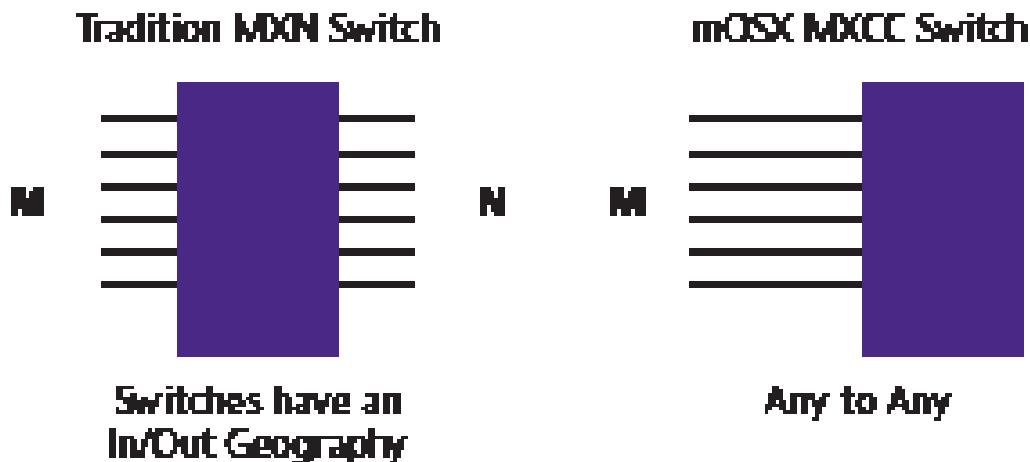

Figure 1. MxN switch topology have an inherent directionality. Ports on the M-side can connect to any N-side port, however M-side ports cannot connect to each other. In an any-to-any or “Common Connection” switch a port can connect to any other port

Making a connection is as simple as identifying the two ports ID's to be connected. As a software option to aid in connection management, it is possible to assign the switch a specific MxN topology (for example 4x12). In this case, connections will only be allowed if they follow the the programmed structure. In full any-to-any mode, all connections are possible.



Figure 2. mOSX-C1 MAP-300 add channel dialogue example. On the left, the switch is set to 4x20 and on the right in full common connection mode.

An intuitive graphic user interface (GUI) is optimized for use in either a laboratory or a manufacturing environment. All ports can be given a logical name to help manage complex systems. Efficient transition between summary and detailed views (figure 2, 3 and 4) allow users to operate at a system level or access the full power of a module.

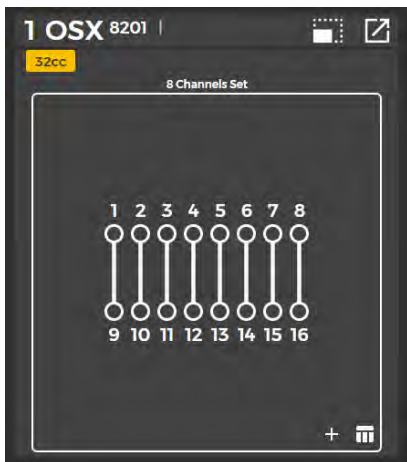

Figure 3. mOSX-C1 MAP-300 GUI provides simple visual switch status



Figure 4. mOSX-C1 MAP-300 summary view with port labels. Active paths shown with check box

Options and Configurations

The mOSX-C1 is offered in a 16-port and 32-port variants. The switches are offered in the following configurations.

Number of ports	Connector Type	Slot width
16 ports	LC/APC and LC/PC	Single
	FC/PC, FC/APC, SC/PC and SC/APC	Dual width
32 Ports	LC/APC and LC/PC	Dual Width

Specifications

Parameter ¹	Specification
Matrix Size	16 or 32 ports
Connection Type	Any port to any port
Operating Wavelength Range	1260 nm 50 1675 nm
Insertion Loss (IL)²	
Active Connection Maximum	≤1.5 dB
Open Port	> 55 dB
Inactive Connection	> 55 dB
Return Loss (RL) ³	> 50 dB
Polarization Dependent Loss (PDL) ⁴	< 0.1 dB
Repeatability ⁵ (maximum)	± 0.05 dB
IL stability ⁶ (maximum)	± 0.05 dB
Wavelength Dependent Loss (WDL) ⁷	≤ 0.3 dB
Temperature Dependent Loss (TDL) ⁸	≤ 0.2 dB
Crosstalk (maximum)	- 55 dB
Max input power (optical)	500 mW (27 dBm)
Switching time	≤ 25 ms
Fiber Type ⁹	Single Mode
Dark Fiber Switching	Yes
Bi-Direction Optics	Yes
Lifetime	> 10 ⁹ Cycles
Warming up Time	60 min
Operation temperature	10 °C to 40 °C
Operation humidity	< 85% RH non-condensing
Storage temperature	-40 °C to +70 °C, <40% RH non-condensing
Dimensions (W x H x D)	Single Slot: 4.1 x 13.3 x 37.0 cm Dual Slot: 8.1 x 13.3 x 37.0 cm
Weight	Single Slot: 1.75kg Dual Slot: 3.1kg

1. Unless otherwise stated, all tests done with a depolarized source at 20°C in a temperature-controlled chamber after thermal equalization

2. Including one pair of connectors; tested at 1550 nm

3. Tested with APC connectors at 1550nm

4. For wavelength range of 1530nm – 1675nm. Tested at 1550nm

5. Measured between two consecutive readings over 100 cycles

6. Any channel drift relative to reference channel at constant temperature over 15 mins period

7. For wavelength range of 1530nm – 1675nm

8. Over the temperature range 15 to 35 °C at 1550 nm after thermal stabilization

9. For IEC 60793-2-50 Type B1.3/ISO 11801 OS2 compliant fiber, i.e. Corning SMF-28e

Ordering Information

For more information on this or other products and their availability, please contact your local VIAVI account manager or VIAVI directly at 1-844-GO-VIAVI (1-844-468-4284) or to reach the VIAVI office nearest you, visit viavisolutions.com/contacts.

Order Number	Item Description	Configuration
16-Port Common Connection Optical Matrix Switch		
MOSX-C1116XCCB0-M100-MFA	16 port common connection SMF optical matrix switch FC/APC bulkhead	Single Slot
MOSX-C1116XCCB0-M100-MFP	16 port common connection SMF optical matrix switch FC/PC bulkhead	
MOSX-C1116XCCB0-M100-MLC	16 port common connection SMF optical matrix switch LC/PC bulkhead	Dual Slot
MOSX-C1116XCCB0-M100-MLU	16 port common connection SMF optical matrix switch LC/APC bulkhead	
MOSX-C1116XCCB0-M100-MSC	16 port common connection SMF optical matrix switch SC/PC bulkhead	
MOSX-C1116XCCB0-M100-MSU	16 port common connection SMF optical matrix switch SC/APC bulkhead	
32-Port Common Connection Optical Matrix Switch		
MOSX-C1132XCCB0-M100-MLC	32 port common connection SMF optical matrix switch LC/PC bulkhead	Dual Slot
MOSX-C1132XCCB0-M100-MLU	32 port common connection SMF optical matrix switch LC/APC bulkhead	

Optical Power and Spectral Measurement

Optical power meters are available in panel mount or remote head, all with varying performance levels for general purpose applications to high power and even premium performance applications. Available in single, dual or quad free air coupled InGaAS power heads.

VIAVI also offers a high-resolution optical spectrum analyzer (HROSA) based on coherent detection, made of no moving part and providing precise characterization of the spectral features of optical signals, with superior resolution and absolute accuracy to conventional OSAs.



Optical Power Meter (mOPM-C1)

MAP Series InGaAs Optical Power meter

The Multiple Application Platform (MAP) Optical Power Meter module (mOPM-C1) is a third-generation power meter that brings a range of panel-mount and remote-head configurations to the VIAVI Solutions MAP series.



The MAP Optical Power Meter (mOPM-C1) module extends the optical power measurement capability of the MAP series by offering four grades of optical performance in panel-mount or remote-head configurations with 1, 2, or 4 inputs per module. Designed with 4 unique performance ranges, versions are available for all applications. Models with 110dBm dynamic range are complimented by versions that support 26dBm input power.

The mOPM can be used for numerous applications such as measuring DUT settling time, cross talk, rise and fall times. It can also be used to measure synchronization and insertion loss stability. Also, allows for performance comparison (for example, comparing sequential switching to random switching).

Functional Description

All four performance grades are based on indium gallium arsenide (InGaAs) detectors and are suitable for applications using single-mode (SM) or multimode (MM) fiber. The response of the detector varies with the wavelength of the incident light. All versions feature high accuracy, high linearity, and extremely low polarization dependent loss (PDL). The high- and ultra-high-performance grades feature enhanced thermal stabilization. This enhances the wavelength range, enabling 90 dB dynamic range for the high-performance grade and 110 dB dynamic range for the ultra-high-performance grade. The high-power grade extends high-power measurement capability to +27 dBm.

Features and Benefits

- Panel-mount or remote-head configuration
- Single-, dual-, or quad-channel configurations available
- 250 kHz sampling rate for high-speed applications
- 750 to 1700 nm operating wavelength range
- 110 dB dynamic range and high-power options
- Compatible with single-mode and multimode fiber
- Ability to store up to 100,000 data points per channel

Applications

- Amplifier characterization
- Receiver and transmitter testing
- Absolute power measurement
- Optical switching time measurement

Compliance

- CE, CSA/UL/IEC61010-1, and LXI Class C requirements (when installed in a MAP chassis)

The mOPM uses detectors with intrinsically low uncertainty due to polarization: $< \pm 0.01$ dB for the Premium-Performance and $< \pm 0.015$ dB for the General-Purpose detector options. This helps maintain high repeatability in power measurements, virtually independent of the launch polarization of the light entering the detector. In general uncertainty due to polarization is less of a concern for high power measurement applications. Due to the filter element employed for the High-Power detector option, this value is $< \pm 0.07$ dB.

An intuitive graphic user interface (GUI) is optimized for use in either a laboratory or a manufacturing environment.

Efficient transition between summary and detailed views (figure 1 and figure 2) allow users to operate at a system level or access the full power of a module.

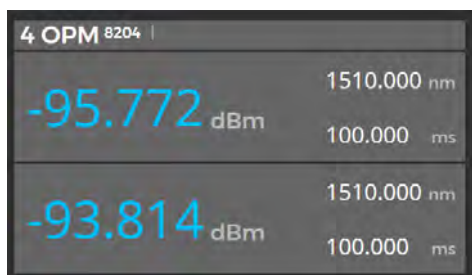

Figure 1 – mOPM MAP-300 summary view GUI

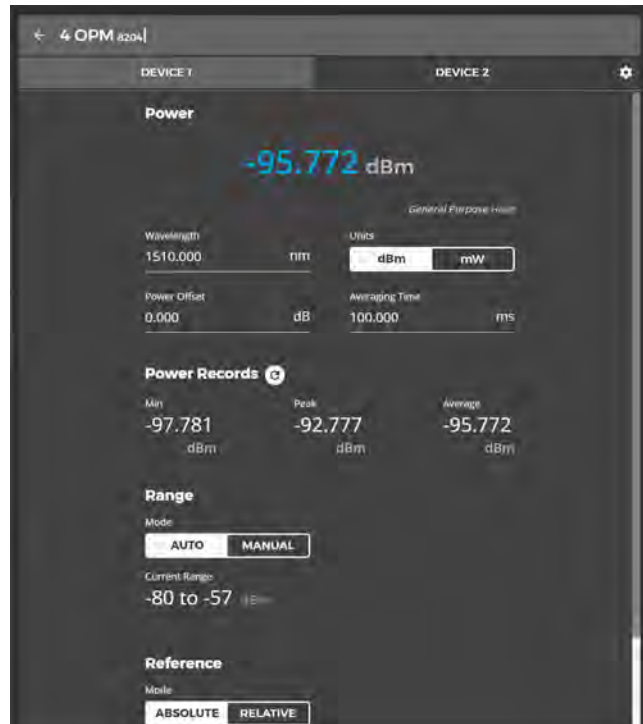

Figure 2 – mOPM MAP-300 detailed view GUI

Options and Configurations

The mOPM-C1 is available in four detector types in 1,2 or 4 detectors per cassette. It is also offered in cassette mounted or remote detector option.

	Options	Description
Detector type	2mm InGaAs General Purpose	<ul style="list-style-type: none"> Measures power levels from -70 to +11 dBm over the wavelength range of 800 to 1650 nm. Features high accuracy, very linear behavior and low relative uncertainty due to polarization.
	3mm InGaAs Premium performance	<ul style="list-style-type: none"> Measures power levels from -80 to +11 dBm over the wavelength range of 750 to 1700 nm. Features high accuracy, very linear behavior and extremely low relative uncertainty due to polarization.
	3mm InGaAs Ultra performance	<ul style="list-style-type: none"> Measures power levels from -110 to +11 dBm over the wavelength range of 750 to 1700 nm. In addition to the features of the Premium Performance detector, the Ultra Performance detector offers excellent stability for long term measurement of extremely low optical power levels. Only available as a panel mount.
	Filtered 2mm InGaAs High power	<ul style="list-style-type: none"> Measures power levels from -45 to +27 dBm over the wavelength range of 800 to 1650 nm. Features high accuracy as well as very linear behavior.
	Integrated remote heads	<ul style="list-style-type: none"> Measures absolute power +33dB input power 80dB dynamic range Larger input aperture Premium performance and PCT version
Flexible Detector Configuration	Cassette-mounted	<ul style="list-style-type: none"> Detectors mounted directly on the cassette faceplate. Configuration, the density available is 1, 2 or 4 detectors per single width cassette. Must configure with identical detector type.
	Remote detector	<ul style="list-style-type: none"> With electrical connectors to which remote detector heads can be attached. Configuration, the density available is 1, 2 or 4 detectors per single width cassette. Flexibility with remote heads to mix detector types.

The interface module is compatible with all performance grades of remote heads and can accommodate a mix of performance grades. For example, an application requiring a general-purpose optical power measurement (OPM) and a high-power OPM could be connected to the same remote head base module, thereby reducing the number of slots used in the MAP chassis.

Integrated Remote Heads

The VIAVI integrated remote heads feature a Teflon-based integrating sphere to minimize polarization-dependent loss and access high power. Available as a premium-performance variant and a variant specifically designed for use with MAP-PCT systems, integrated remote heads provide 90° launch and ideal spherical geometry for maximum repeatability. The integrated remote heads can measure high powers of >20dBm and 80dB dynamic range that can be used for amplifier and/or pump laser testing. They also provide a larger input aperture that is ideal for high port MPO connectors or duplex connectors. They are Measure IL for high port count MPO connectors with < 0.01dB positional variations.

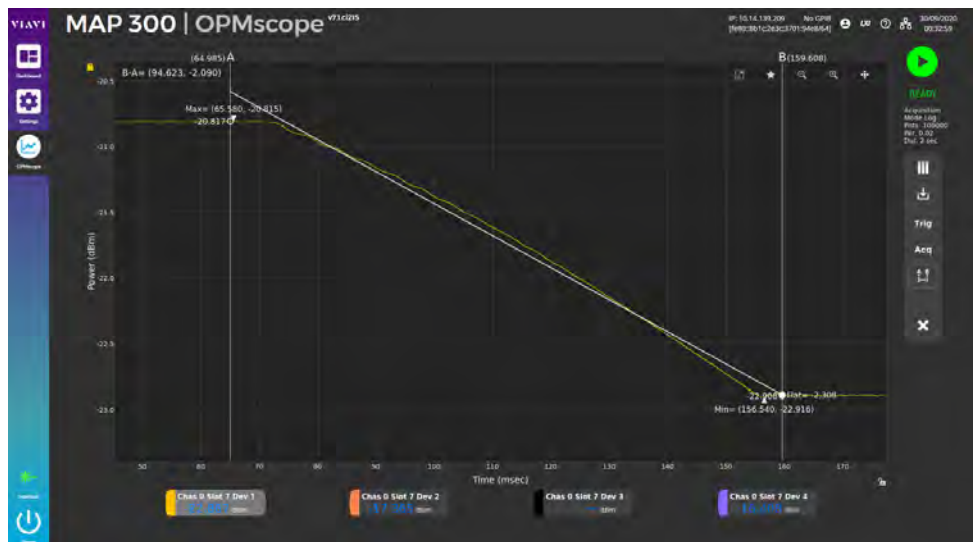

Figure 3 - Integrated Remote Head OPM in MAP-330

Super Application: OPMscope

The OPMscope is a super application designed for use with the mOPM-C1 line of power meters on the MAP-200 and 300 platforms. This software feature is an intuitive tool geared for designers and allows graphical representation of optical signals, much like a digital sampling scope, but in the optical domain. This tool can be used to trigger on rising or falling edges, with the ability to see history using pre-trigger data points. It lets users pan and zoom to see details and monitor transients and exports up to 100,000 captured data for extended analysis from up to four optical heads simultaneously.

The new MAP-300 platform offers an enhanced OPMscope user experience. It allows the user to gather traces from up to 8 mainframes with a maximum offering of 256 devices, while MAP-200 offers only 4 traces. The MAP-300 super application offers enhanced markers and data export.



Specifications

For more information on this or other products and their availability, please contact your local VIAVI account manager or VIAVI directly at 1-844-GO-VIAVI (1-844-468-4284) or to reach the VIAVI office nearest you, visit viavisolutions.com/contacts.

Parameters	General Purpose	Premium Performance	Ultra Performance	High Power
Detector type	InGaAs	TEC InGaAs	TEC InGaAs	Filtered InGaAs
Detector size	2 mm	3 mm	3 mm	2 mm
Wavelength range	800 – 1650 nm	750 – 1700 nm	750 – 1700 nm	800 – 1630 nm
Fiber type ¹		SMF and MMF with NA 0.27 (maximum core size 62.5 μm)	SMF and MMF with NA 0.27 (maximum core size 62.5 μm)	
Dynamic range	+11 dBm to –70 dBm	+11 dBm to –80 dBm	+11 dBm to –100 dBm	+27 dBm to –45 dBm
Uncertainty at reference conditions ²	±2.5% (800 – 1510 nm) ±2.4% (1510 – 1600 nm) ±2.7% (1600 – 1635 nm)	±2.2% (800 – 1510 nm) ±2.3% (1510 – 1600 nm) ±2.5% (1600 – 1635 nm)	±2.2% (800 – 1510 nm) ±2.3% (1510 – 1600 nm) ±2.5% (1600 – 1635 nm)	±3.9% (800 – 960 nm) ±3.6% (960 – 1300 nm) ±3.7% (1300 – 1510 nm) ±3.8% (1510 – 1600 nm) ±4.0% (1600 – 1635 nm)
Total uncertainty ³	±3.2 % ±5 pW (800 – 900 nm) ±5.2 % ±5 pW (900 – 960 nm) ±3.1 % ±5 pW (960 – 1510 nm) ±3.1 % ±5 pW (1510 – 1600 nm) ±3.8 % ±5 pW (1600 – 1635 nm)	±3.0% ±1 pW (800 – 1510 nm) ±3.1% ±1 pW (1510 – 1600 nm) ±3.4% ±1 pW (1600 – 1635 nm)	±3.0% ±0.2 pW (800 – 1510 nm) ±3.1% ±0.2 pW (1510 – 1600 nm) ±3.4% ±0.2 pW (1600 – 1635 nm)	±4.6% ±100 pW (800 – 900 nm) ±7.9% ±100 pW ⁶ (900 – 960nm) ±3.9% ±100 pW (960 – 1300 nm) ±4.4% ±100 pW (1300 – 1510 nm) ±4.5% ±100 pW (1510 – 1600 nm) ±5.2% ±100 pW (1600 – 1635 nm)
Linearity (at 23 ±5°C)	±0.010 dB ±5 pW	±0.010 dB ±1 pW	±0.010 dB ±0.1 pW	±0.010 dB ±100 pW (for –45 dBm to +10 dBm) ±0.03 dB (for +10 dBm to +27 dBm)
Noise (peak to peak) ⁴	2 pW	1 pW	<0.1 pW	50 pW
Return loss	>55 dB type			
Relative uncertainty due to polarization ⁵	±0.015 dB	±0.01 dB	±0.01 dB	±0.07 dB
Maximum number of channels (panel mount)	1,2 or 4			
Sampling time	4 μs (250 kHz)			
Averaging time	20 μs to 5 s			
Buffer size	100,000 points			
Supported connectors ⁷	FC, ST, LC, E2000, MU, MTP or bare fiber			
Recalibration period	1 year			
Warm-up time	30 min			
Operating temperature	5 to 40°C	5 to 40°C	5 to 33°C	5 to 40°C
Humidity	15 – 80% relative humidity, non-condensing			
Module				
Dimensions (W x H x D)	4.06 x 13.26 x 37.03 cm (1.6 x 5.22 x 14.58 in)			
Weight	1.2 kg (2.65 lb)			
Remote Head				
Cable length	1.4 m (4.5 ft)			
Dimensions	13.8 cm x 5 cm x 5 cm (5.4 in x 2 in x 2 in) excluding cable			
Weight	0.6 kg (1.3 lb)			

¹For 62.5 μm core fiber, additional uncertainty of 1% (PC) or 2% (APC) must be added due to overfill of 2 mm detector.

²Fiber SMF-28, T = 23 ±5°C, spectral width of source <6 nm, optical power on detector = –20 dBm.

³SMF 28, N/A of fiber ≤0.27, temperature, humidity, and power range per table.

⁴1 second averaging time, 300 consecutive measurements (300s), T = 23 ±5°C.

⁵All states of polarization, constant power, straight connector, T = 23 ±5°C WL = 1550 nm ±30 nm, MPMHP at WL = 1310 nm.

⁶For 900 – 960 nm only, uncertainty indicated is for 15 – 35°C.

⁷Note that MT connector size prevents the use of adjacent channels. Therefore, a 4-channel cassette only allows 2 MT input at a time.

Specifications continued

Parameters	Premium Performance (mOPM-C1RHIS)	PCT System (mOPM-C1RHIP)
Detector type	InGaAs	
Detector size	3mm	2mm
Wavelength range	750 – 1700 nm	800 – 1650 nm
Fiber type	SMF and MMF with NA 0.33 (maximum core size 2000 µm)	
Dynamic range	+33 dBm to -55 dBm	+3 dBm to -55 dBm
Uncertainty at reference condition ¹	±4.4% (800 – 950 nm)	±4.5% (800 – 950 nm)
	±2.5% (960 – 1635 nm)	±2.9% (960 – 1635 nm)
Total uncertainty ²	±4.6% ±60 pW (800 – 950 nm) -55dBm to +10dBm	+ - 4.9% ± 100 pW (800 0 950 nm)
	±3.7% ±60 pW (960 – 1635 nm) -55dBm to +10dBm	±3.7% ±100 pW (960 – 1635 nm)
	±4.7% (800 – 950 nm) +10dBm to +20dBm	-
	±3.8% (960 – 1635 nm) +10dBm to +20dBm	
	±5.0% (800 – 950 nm) +20dBm to +33dBm	
	±4.0% (960 – 1635 nm) +20dBm to +33dBm	
Total uncertainty Linearity (at 23 ±5°C)	±0.010 dB ±100 pW (-55 dBm to +10dBm)	±0.010 dB ±150 pW (-55 dBm to +3dBm)
	±0.03 dB (+10 dBm to +20 dBm)	
	±0.06dB (+20 dBm to +33 dBm)	
Noise (peak to peak) ³	60 pW	100 pW
Return loss	>55 dB typical	>55 dB typical
Relative uncertainty due to polarization ⁴	≤ ±0.005 dB	≤ ±0.005 dB
Maximum number of channels (Panel mount)	1,2, or 4	1,2, or 4
Recalibration period	>55 dB	>55 dB
Warm-up time	30 minutes	
Operating temperature	5 to 40°C (41 to 104°F)	
Humidity	RH 15-80%, non-condensing	

¹Fiber SMF-28, T = 23 ±5°C, spectral width of source <6 nm, continuous wave, power level of -20 dBm.

²SMF 28, N/A of fiber ≤ 0.27, input at center of sphere, temperature, humidity, and power range per table.

³1 second averaging time, 300 consecutive measurements (300s), T = 23 ±5°C.

⁴All states of polarization, constant power, straight connector, T = 23 ±5°C, WL = 1550 nm ±30 nm.

Ordering Information

Description	Part Number
Panel-Mount Sensor Option	
Single channel	MOPM-C1PMH1-MPMxxxx
Dual channel	MOPM-C1PMH2-MPMxxxx
Quad channel	MOPM-C1PMH4-MPMxxxx
Remote Head Base Cassette	
Single channel remote interface cassette	MOPM-C1RH1
Dual channel remote interface cassette	MOPM-C1RH2
Quad channel remote interface cassette	MOPM-C1RH4
Remote Head Option	
2mm InGaAs general purpose head cassette	MOPM-C1RHGP
2mm InGaAs high power remote head	MOPM-C1RHHP
2mm InGaAs PCT system remote head	MOPM-C1RHPCT
3mm InGaAs Premium purpose remote head	MOPM-C1RHPP
Integrated Remote Head Options	
Integrated premium performance remote head	MOPM-C1RHIS
Integrated PCT system remote head	MOPM-C1RHIP
Applications	
Optical scope licensed super application for MOPM-B1 and mOPM-C1 power meters	MSUP-OPMSCOPE
Optical scope licensed super application for mOPM-C1 cassettes	MSUP-300A-OPMSCOPE

Sample Configurations for Panel Mount

Type of Detector	Single Channel	Dual Channel	Quad Channel
General Purpose	MOPM-C1PMH1-MPMGP	MOPM-C1PMH2-MPMGP	MOPM-C1PMH4-MPMGP
High Power	MOPM-C1PMH1-MPMHP	MOPM-C1PMH2-MPMHP	MOPM-C1PMH4-MPMHP
Premium Performance	MOPM-C1PMH1-MPMPP	MOPM-C1PMH2-MPMPP	MOPM-C1PMH4-MPMPP
Ultra Performance	MOPM-C1PMH1-MPMUP	MOPM-C1PMH2-MPMUP	MOPM-C1PMH4-MPMUP

Note: All mOPM-C1 come with 1,2 or 4 FC detector adaptors (AC901)



Shown: mOPM-C1 module and remote head with module.

© 2020 VIAVI Solutions Inc.
 Product specifications and descriptions in this document are subject to change without notice.
 mapopm-ds-lab-tm-ae
 30162691 907 0920

mHROSA-A1

MAP-200 Integrated Multi-Wavelength Wavemeter and High-Resolution Optical Spectrum Analyzer (OSA)

VIAMI brings next-generation innovation in wavelength testing to optical lab and manufacturing environments. The new MAP-based integrated multi-wavelength meter and high resolution OSA module (mHROSA) combines sub-GHz resolution performance and compact modularity in a single-slot cassette.

Supported in MAP-230B and MAP-280 mainframes, the mHROSA can take advantage of the wide array of other VIAMI MAP modules, such as power meters, attenuators, switches, sources, and a range of signal conditioning modules. It is a richly featured multi-wavelength meter and high-resolution OSA with analysis features that can be controlled through an easy-to-use GUI or the MAP-200 automation interface.

Based on coherent detection techniques, the mHROSA has no moving parts and it provides unprecedented frequency resolution to precisely report the power level and central frequencies of densely spaced optical signals as close as 2 GHz.

The ground-breaking mHROSA provides the ideal solution for both lab and manufacturing test systems, where reliability, compactness, and performance are critical.

Platform Compatibility

MAP-230B



3-slot mainframe

MAP-280/MAP-280R



8-slot mainframe

Key Benefits

- Industry's first integrated multi-wavelength meter and high-resolution OSA for lab and production
- Enables sub-GHz resolution analysis of optical signals
- Supports 400 G Nyquist flexible grid WDM signal analysis
- MAP-based modular design enables process integration into more comprehensive optical devices
- A complement to the comprehensive MAP solution portfolio
- No moving parts

Key Features

- Sub-GHz wavelength resolution
- Extended C-band acquisition range
- Measures frequency, power level, and OSNR
- Continuous and averaging test modes
- Measures Side-mode suppression ratio

Applications

- DWDM transmission systems
- Optical sources
- Transponders and linecards
- Qualify 10/40/100/400 G components and systems
- Validate and deploy 100 G and 400 G flex-grid DWDM



Specifications (at 25°C over the entire frequency range)

Spectral	
Optical frequency (wavelength) range	191.1 – 196.25 THz
Absolute uncertainty of frequency (wavelength) ^{1,2}	±370 MHz (±3 pm)
Minimum resolvable separation	2 GHz (16 pm)
Resolution bandwidth	300 MHz
Display resolution	0.0001 nm
Power	
Input power range ³	–60 to +10 dBm
Noise floor	–75 dBm
Max. total input power ⁴	+17 dBm
Close-in dynamic range	>40 dB at ±8 pm (±1 GHz) >50 dB at ±16 pm (±2 GHz)
Spurious-free dynamic range	>45 dB
Absolute uncertainty of power level ^{1,5}	±0.5 dB
Power linearity ⁶	±0.4 dB
Polarization dependence	±0.2dB
Display resolution	±0.01 dB
Other	
Return loss	>50 dB
Measurement time ⁷	min 1.0 s
Fiber type	9/125 μm single-mode fiber
Connector type	FC/APC
Operating temperature	10 to 40°C
Storage temperature	–20 to +50°C
Humidity	Maximum 95% RH from +10 to +40°C noncondensing
Dimensions	4.06 x 13.26 x 37.03 cm
Weight	1.4 kg
Calibration period	1 year

1. Over the entire frequency range.

2. Average of five consecutive sweeps.

3. Power of unmodulated single-frequency laser or peak power of modulated signal in 300 MHz optical bandwidth.

4. Total power for all input signals.

5. At –20 dBm input power.

6. For input power from –10 to –40 dBm.

7. Over 50 GHz sweep range, no averaging.

Ordering Information

Description	Part Number
MAP-200 extended C-band integrated multi-wavelength meter and high-resolution optical spectrum analyzer	mHROSA-A1CB10



HROSA GUI with graphing capability and analysis tools



Wavemeter GUI with tabulated wavelengths, powers, and low-resolution graph

MAP Series Power Meter Detector Adaptors

AC Detector Adaptors are designed for use with the VIAVI MAP series optical power meters (mOPM), Insertion Loss/Return Loss Meters (mORL and mOLM) and Swept Wavelength System (mSWS); the Optical Component Environmental Test System (OCETS); and legacy JDSU product lines.

For more information about detector compatibility, or if you need an Adaptor not listed, contact the Technical Assistance Center (TAC) for support: support@viavisolutions.com



The AC900 series detector Adaptors feature three locking pins for improved measurement precision. They can be used with all current mOPM, mORL, mOLM, and mSWS detectors, as well as legacy JDSU C-Series instruments.

AC100 series Adaptors are thread-on Adaptors without the locking pins of the AC900 series. These Adaptors are compatible with all current mOPM, mORL, mOLM, and mSWS detectors, as well as legacy JDSU MAP power meter, return loss meter, and SWS detectors.

Single Fiber Connector Adaptors

Detector Adaptors for use with most common single-fiber ferrule connectors. The AC900 series Adaptors have three locking pins and are compatible with all current MAP series mOPM, mORL, mOLM and mSWS detectors. The AC100 series Adaptors do not have locking pins and are compatible with all current and legacy detectors.

Catalog Part Number	Connector Type	Adaptor Image		Connector Image
AC100	N/A		Blanking Cap	
AC102	ST		ST Adaptor, non-locking	
AC115	E2000		E2000 Adaptor, non-locking	
AC900	N/A		Magnetic dark level cap	
AC901	FC		FC Adaptor, locking	
AC903	SC		SC Adaptor, locking	
AC914	MU		MU Adaptor, locking	
AC918	LC		LC Adaptor, locking	

Duplex-Fiber Adaptors

Detector Adaptors for use with most common Duplex-Fiber connectors. These Adaptors have three locking pins and are compatible with all current MAP series mOPM, mORL, mOLM, and mSWS detectors.

Catalog Part Number	Connector Type	Adaptor Image	Description	Connector Image
AC918D	LC Duplex		LC Duplex Adaptor, locking	
AC937D	CS Duplex		Duplex CS, locking	
AC938D	SN Duplex		Duplex SN, locking	

Multi-Fiber Connector Adaptors

Detector Adaptors for use with most common multi-fiber ferrule connectors. These adaptors have three locking pins and are compatible with all current MAP series mOPM, mORL, mOLM, and mSWS detectors. Note: A VIAVI AC900 series integrating sphere is required for use with these adaptors.

Catalog Part Number	Connector Type	Adaptor Image	Description	Connector Image
AC912P	MT Ferrule		MT ferrule Adaptor – universal 12x6 and 16x4 array, locking	
AC917U	MPO-MTP Universal Keyed		MPO-MTP Adaptor – universal keyed 12x6 and 16x4 array, locking	
AC924P	MXC		MXC Adaptor – 16x4 array, locking	

Hardened Connector Adaptor

Connector Adaptors are available for outdoor connectors. These Adaptors have three locking pins and are compatible with all current MAP-Series mOPM, mORL, mOLM, and mSWS detectors

Catalog Part Number	Connector Type	Adaptor Image	Description	Connector Image
AC932	DLX		DLX Adaptor, locking	
AC933	OptiTap		OptiTap Adaptor, locking. Requires an AC991S integrating sphere	
AC935	OptiTip/ HMFOC		HMFOC/OptiTip Adaptor, locking. Requires an AC900 series integrating sphere	

Single Fiber Ferrule Adaptors

Detector Adaptors for use with most common single-fiber ferrules. These Adaptors do not have locking pins and are compatible with all current and legacy detectors.

Catalog Part Number	Connector Type	Adaptor Image	Description
AC116	2.5 mm ferrule		2.5 mm ferrule Adaptor, non-locking
AC116L	2.5 mm ferrule and LC		2.5 mm ferrule Adaptor and LC connector Adaptor, non-locking
AC123	1.25 mm ferrule		1.25 mm ferrule Adaptor, non-locking
AC135	2.0 mm ferrule		2.0 mm ferrule Adaptor, non-locking
AC136	1.0 mm ferrule		1.0 mm ferrule Adaptor, non-locking
AC137	1.6 mm ferrule		1.6 mm ferrule Adaptor, non-locking

Bare-Fiber Adaptors

Detector Adaptors for use with bare fiber (single or ribbon). The fiber Adaptor fits inside the holder, which is attached to the detector.

A VIAVI integrating sphere is not required but is recommended for use with these Adaptors.





Catalog Part Number	Connector Type	Adaptor Image	Description
AC121	Bare Single Fiber		Single-fiber Adaptor, non-locking (one AC920 included)
AC913	Bare Single Fiber		Ribbon-fiber Adaptor, up to 16 fibers, locking (one AC920 included). Requires an AC991S integrating sphere
AC920	Bare Ribbon Fiber		Replacement holder for bare-fiber Adaptor AC913. Also suitable for bare-fiber Adaptor AC121 and AC113, locking
AC930	Bare Ribbon Fiber		Barrel holder for AC931, locking
AC931	Fujikura-Sumitomo splice		Fujikura-Sumitomo splice chuck holder, requires AC930

Integrating Spheres

Catalog Part Number	Connector Type	Adaptor Image	Description
AC991S	Multi-fiber connectors		Integrating sphere for multi-fiber connectors optimized for SM APC and 12x6 and 16x4 array, locking
AC330	Single-Fiber		Single-fiber, high power, low PDL integrating sphere, 1.0 mm aperture, non-locking

Bulkhead Adaptors and Replacement Parts

Bulkhead Adaptors are ordered as mating sleeves, these Adaptors can be separated into two halves and used to replace worn connector bulkhead Adaptors on MAP modules. The inserts for the MPO detector Adaptors come with five pieces of each key type: Center, Offset and Universal, as well as instructions for installation.

Catalog Part Number	Connector Type	Adaptor Image	Description
AC500	FC/PC to FC/PC		FC/PC to FC/PC mating sleeve or replacement bulkhead, 2.15 mm keyway
AC501	FC/PC to SC/PC		FC/PC to SC/PC mating sleeve or replacement bulkhead, 2.15 mm keyway
AC502	FC/APC to FC/APC		FC/PC to FC/APC mating sleeve or replacement bulkhead, 2.05 mm keyway
AC503	FC/APC to SC/APC		FC/PC to SC/APC mating sleeve or replacement bulkhead, 2.05 mm keyway
ACRI917	MPO-MTP		Internal connector inserts for AC917U 5 pieces

LightTest Solutions

The LightTest family are application specific, integrated test solutions that leverage the power of the MAP Series Super-Application or PC based software. The light test family provides solutions to passive components tests including insertion loss (IL), return loss (RL), polarization dependent loss (PDL), and directivity. These characterizations are useful for ROADM, DWDM, component validation and environmental tests.



LightTest Family

The LightTest family are application specific, integrated test solutions that leverage the power of the MAP Series Super-Application or PC based software. Built with specialized MAP modules or assemblies of LightDirect modules, LightTest solutions are typically used in bench test applications but can also be combined in larger, multi-modules customer driven automated test systems. Light direct families provides solutions to passive components tests including insertion loss (IL), return loss (RL), polarization dependent loss (PDL), and directivity. These characterizations are useful for ROADM, DWDM, component validation and environmental tests.



Passive Connector Test	MAP Swept Wavelength System	OCETS
<p>Passive Connector Test (PCT) Solutions consists of a powerful family of modules, software, and peripherals for testing IL, RL, physical length, and polarity of optical connectivity products. Leveraging the modularity and connectivity of the VIAMI MAP platforms, the PCT can be configured for R&D, production, or qualification test environments and can address all key fiber types from single mode through OM1 and OM4.</p> <p>The PCT-rm is a MAP-220 based Single mode Insertion Loss (IL) and Return Loss (RL) test meter for single fiber connector applications. Part of the MAP-Series PCT solution family, it features fully EF-compliant multimode Insertion Loss test meters with connector adapters that can be configured for all connectivity applications to ensure maximized productivity.</p>	<p>mSWS are swept wavelength test solutions for manufacturing and new device development of passive DWDM devices, ROADMs & Circuit Packs. Provides full characterization of wavelength dependence performance.</p>	<p>OCETS (Optical Component Environmental Test Systems) are designed with a pair of custom-grade programmable switches (1xN configuration) that are specified to higher levels of IL repeatability and background RL than analogue-grade switches. Therefore, the implementation of an OCETS Plus system represents an improvement over the capability of any in-house system that utilizes analogue-grade switches.</p>

Insertion Loss/Return Loss Testing Solution (mORL)

mORL with Passive Component Testing (PCT) Application for MAP-Series

The Passive Component/Connector Test solution (PCT) from VIAVI Solutions consists of a powerful family of modules, software, and peripherals for testing IL, RL, physical length, and polarity of optical connectivity products. Leveraging the modularity and connectivity of the VIAVI MAP Series platform, the PCT can be configured for R&D production, or qualification test environments and can address all key fiber types from single-mode through OM1, OM4 and OM5.

Optical connectivity solutions (optical connectors, structured cabling, splitters, and the enclosures that house them) are central to connection-intensive central office, data center, and optical-distribution networks. Outside of telecom, datacom, wireless backhaul, and FTTx, new supercomputing applications are emerging, and naval, avionic, and military applications continue to multiply. All of these markets are driven by the demand for more bandwidth. Out of necessity, new connector formats are coming to market, driven by the need to lower installation costs and speed deployments.

However, the quality and optical performance of these connection points is often overlooked. Poor insertion and return loss (IL and RL) can have far-reaching impact on network performance. Poor performance can directly affect reach and reliability and can even block the path to technology upgrades. Simultaneously, economic factors require manufacturers to lower costs, speed production, and accelerate time-to-market.



Key Benefits

- Requires only 25% of the space of other solutions
- Enables expansion into new high-growth, high-performance applications such as 40/100 G data center markets
- Modular platform can scale as needs arise and budget allows
- Port mapping verifies multifiber MPO cassette continuity and polarity in less than 15 seconds
- Fully supports high-growth MPO and MTP multifiber connectors

Applications

- Testing IL/RL/length of optical connectors and cable assemblies, structured-cabling solutions, and optical splitters
- Automated testing of multifiber assemblies such as MPO
- Solutions for both single-mode and multimode fiber-based devices
- Verifying continuity and polarity of large multifiber assemblies
- Measuring RL of line cards and receptacle-based transponders

Compliance

- MAP mORL-A1 modules installed in a MAP Series chassis comply with CE, CSA/UL/IEC61010-1, and LXI Class C requirements

Options and Configurations

The PCT system is offered in single-mode and multimode IL and RL modules available in different wavelengths and configurations.

mORL-A1 Single-Mode IL and RL



One slot single mode module contains up to four sources (1310, 1490, 1550, 1625 nm), and integrated power meter, and an optional 2x2 optical switch for automated bidirectional testing.

RL measurements are based on time-domain technology and are often referred to as “mandrel-free.” Mandrel-free technology dramatically reduces test time by eliminating the need to make slow, difficult, manual terminations during both setup and execution of RL measurements. It also measures length, further eliminating the need for extra steps to verify quality. Leveraging decades of OTDR technology, the VIAVI mORL-A1 delivers 80 dB of RL dynamic range and can measure jumpers as short as 70 cm in as quickly as 6 seconds for two wavelengths.

IL is measured using the power meter method. Precise launch power monitoring and depolarization technology provides true 0.001 dB resolution. RL measurements are completed in parallel using the same optical stimulus, requiring less time overall.

mORL-A1 Multimode IL and RL

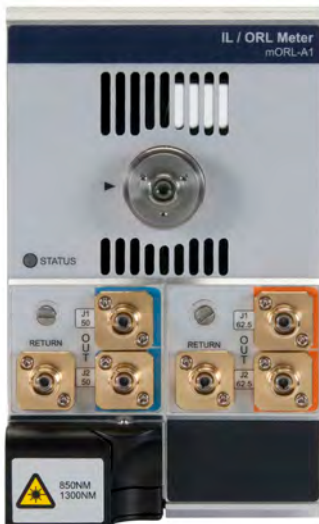
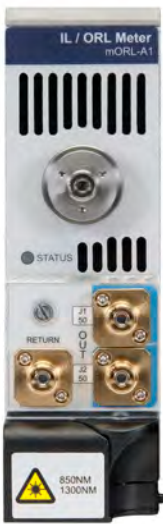

Multimode modules are based on the same basic technology and architecture as the single-mode module described above. A standard dual-wavelength version is available (850, 1300 nm) for multimode applications with an integrated power meter and optional 2x2 optical switches for automated bidirectional testing.

The multimode module requires the selection of fiber type. After years of fighting to balance test capacity investments between 50µm (OM2, 3, 4) and 62.5 µm (OM1), VIAVI released a first-of-its-kind module that tests both fiber types. The dual-fiber option can test 50 µm or 62.5 µm from the same module. Similar to the single-mode version, an optional bidirectional test is available which can also test hybrid assemblies. Measurements of RL from 15 to 60 dB are possible and can be achieved during concurrent IL measurements in less than 2s per wavelength.

IL performance meets IEC 61280-4-1 recommendations for mode fill. For high-throughput testing, the mORL module uses the same laser sources for IL and RL. The multimode module includes a standard set of low-power LED sources from which to select for extra precision. The low-power LED sources offer lower coherence without polarization, removing instability from speckle effects on the power meter surface. Like the single-mode module, launch powers are monitored to achieve an IL stability of ± 0.02 dB.

Bidirectional Multimode and Single-Mode Modules

Simplify workflows with the bidirectional test. The mBID code option adds an internal 2x2 switch to the mORL modules. When coupled with the time-domain RL measurement it dramatically reduces test times because it measures optical RL on both connectors with one connection using the multiple programmable window function. This eliminates the need to measure the jumper in the other direction, effectively cutting test times in half.

PCT Application Framework

The PCT application environment for the mORL-A1 module family is considered a MAP series super-application because it drives the core measurement module as well as several adjacent modules and peripherals (for example, optical switches, barcode reader, and USB printers) for a total application solution. Maintenance utilities can assist users in the field while login rights ensure that only authorized personnel can change the key set-up parameters. It is also offered in multiple languages including English, Spanish, French, Japanese and Chinese.

The PCT Super application is offered in two versions that run natively on the MAP chassis and are offered as choice to the user.

- **PCT Max** (original PCT) has a high focus on test and report management tools, with a supervisor mode layer for creating DUTs, test scripts, and report formatting, and an operator mode layer for high scale production testing with automatic databasing
- **PCT Lite** was launched as a more operator friendly interface for lab users or those who didn't need heavy scripting and automation for production. It is still backed by the stability and horsepower that PCT Max users are familiar with.

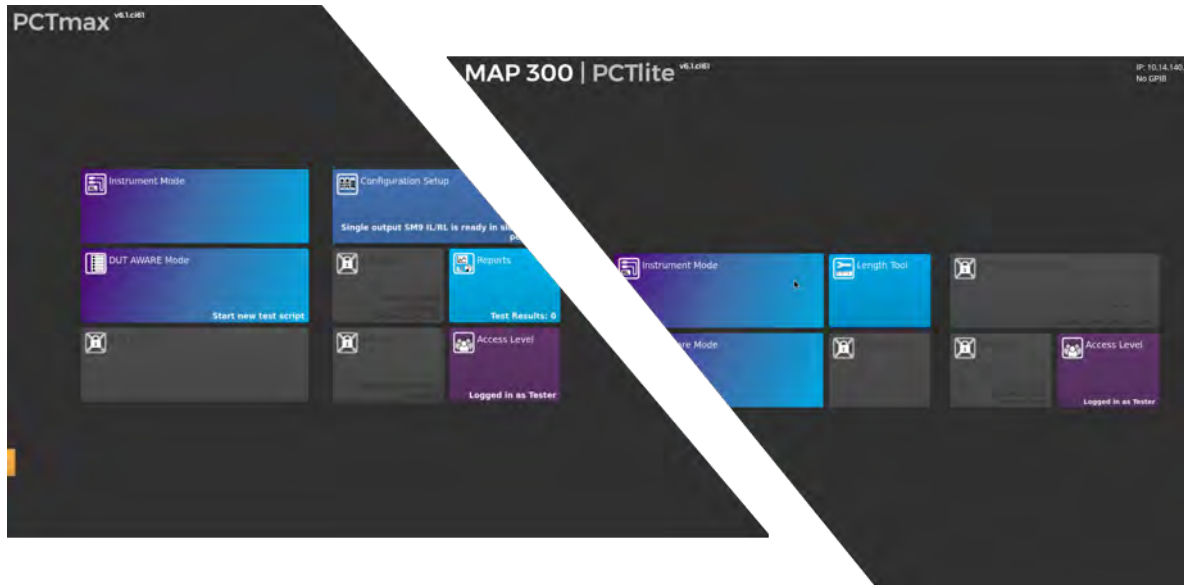

The PCT software has three main operation modes: instrument mode, script mode (DUT aware mode), and port mapping. For more information on port mapping consult the port mapping application note. A full complement of SCPI compliant remote commands is available as well.

1) Instrument Mode

Instrument mode lets users quickly and easily access all the key setup parameters in a simple easy-to-use intuitive GUI, which is ideal for R&D and qualification labs. This feature gives users maximum control in a rapidly changing environment. Users have constant access to interactive windows showing current connections and measurement setups. Quick-save features let users save test results to text files and window settings to simplify recall.

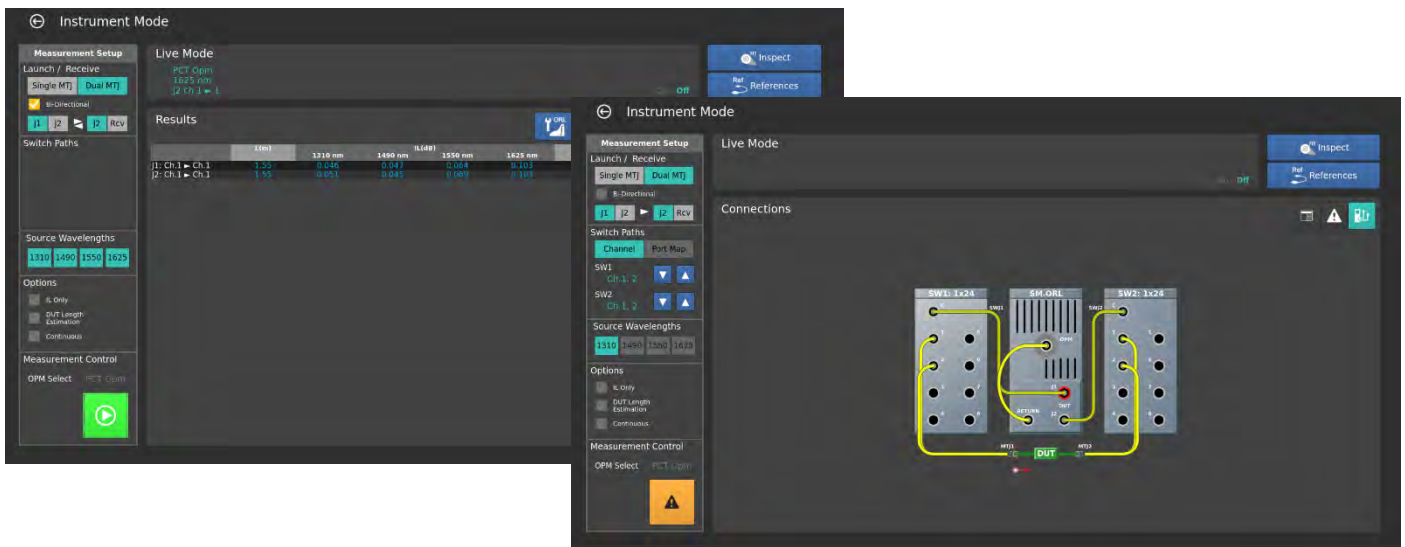

2) Script Mode (DUT Aware Mode)

Script mode fully automates tests with user-programmed test sequences and provides an SQL-light database to store results in a password-protected environment. Serial numbers may be generated locally or entered using a USB barcode reader. User-defined scripts ensure that production procedures are followed strictly while a full HTML editor can be used to embed instructions and photos for operators to follow. Users can print reports and labels or export data from the database for analysis. A database query engine lets users extract results based on criteria such as device control type, connector type, or customer.

Data can be saved locally to the internal flash disk and then exported over USB or the network FTP server. Alternatively, users can store individual test files directly to a mapped network drive. When using the remote network drive, the PCT application can locally cache files, in case the connection to the remote drive is lost and will re-sync automatically once the connection is restored.

3) Remote Commands

Integrating the PCT application with external automation environments, such as LabView and Visual Basic, leverages the full power of the MAP system. Its full set of standard commands for programmable instruments (SCPI)-based commands are accessible through the local area network (LAN) or over the legacy general-purpose interface bus (GPIB) interface. The simple, robust, remote interface is a core requirement of the application. The MAP Series Linux-based operating system eliminates the maintenance requirements of legacy Windows-based platforms and IT department efforts on viruses and network access. A simple Excel-based example is available and may be all that is required for programmers to get started.

For debugging purposes, users can remotely login to the unit remotely via web interface, which is extremely useful when interacting with remote manufacturing locations.

Key Features (FastIL and SEIL)

Fast Insertion Loss Mode (FASTIL)

FASTIL is an IL only mode that offers faster testing speeds with the same accuracy and stability performance as standard IL testing. This is a MAP-200 and 300 feature supported via UI and SCPI. It is ideal for applications where only IL testing is required or for pre-screening measurements to ensure good results prior to detailed measurements.



Single Ended Insertion Loss (SEIL)

SEIL is a MAP-300 supported debug tool. It allows the operator to look into an assembly to visualize regions with unexpected higher IL. It is a post measurement tool intended for fiber lengths greater than 10 meters. SEIL is ideal for complex DUTs with furcation zones that permits the user to visualize where the loss is and cannot be used as a pass/fail method. This tool is supported through a license and can be used via UI or SCPI.



PCT Control Center

PCT Control Center is a companion PC application, designed to maximize the value of the DUT Aware measurement mode. PCT Control Center is compatible with the PCTMax and PCTLite application which leverages the mORL-A1 measurement engine.

A simple, easy to use PC interface enables creating, editing and managing DUT definition files, report templates and serial number batches. Files are saved to a shared directory and allows all PCT units to use these files. If network connectivity is not available, USB storage media can be used to transfer the information. Test results can be uploaded, viewed, filtered and printed using both standard and editable HTML templates.

PCT Control Center is also compatible with PCT-rm for users who wish to migrate to mandrel-free testing.

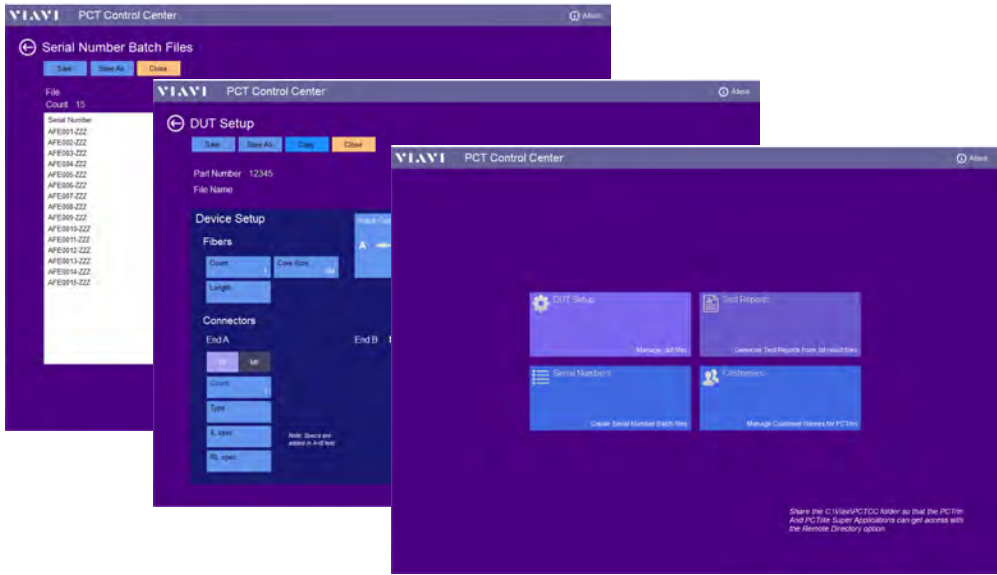

PCT Control Center is a simple PC application designed to simplify management of the PCTMax, PCTLite and PCT-rm based IL and RL systems.

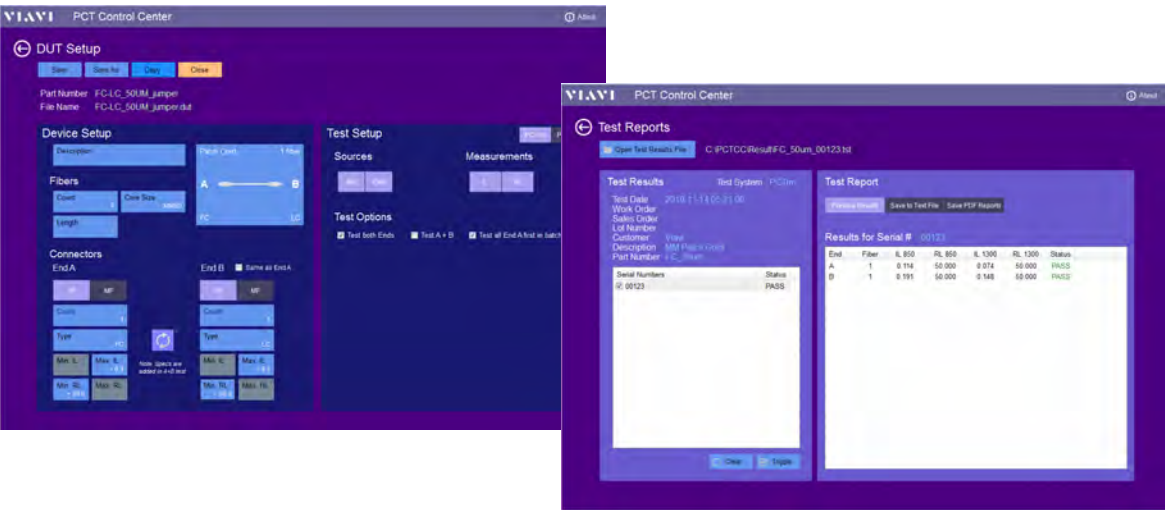

Example of PCTcc used to test hybrid FC/LC Jumpers

Key Peripherals and Accessories

Optical Switches and Remote Power Meter Head

Pairing the mORL with the MAP Optical Switch (mOSW-C1) switch family can expand a single fiber output up to 64 channels. Switches are used to speed workflow and to connect multiple master test jumpers (MTJ) to the system simultaneously. If 64 channels are insufficient, external VIAVI switches can be used and controlled via USB to sequentially test up to 176 fibers hands-free.

The addition of a remote head power meter can also add more flexibility to the system and speed. It is ideal for difficult ergonomics with outside plant or structured cables and Hybrids (MPO to LC breakout). It also allows the addition of more OPMs to the modules (1,2 and 4 heads) and can be used on any chassis in the network. New power head is “paired” during set-up and can be toggled for use during measurement. Pairing operation links all heads. Referencing one, references ALL of them making it a very powerful addition.

VIAVI also offers Teflon-based integrating sphere to minimize polarization-dependent loss and access high power. Integrated remote heads provide a larger input aperture that is ideal for high port MPO connectors or duplex connectors. They are Measure IL for high port count MPO connectors with < 0.01dB positional variations. They can also measure high powers of >20dBm with an 80dB dynamic range.

Third Party Accessories

To simplify workflow, several standard third-party accessories can be used including a standard mouse, keyboard and ASCII text-entry based barcode readers. The unit directly supports two label printers. It also supports network printing on postscript-enabled printers. VIAVI currently supports ZPL compatible Zebra printers.

Connector Inspection

Manufacturers know that contaminated master test jumpers are a major source of test failure if left uncontrolled. The fiber inspection and test application (mSUP-FIT) is a super application that runs parallel to the PCT. A toggle button ensures that the operator is never more than one-button-press away from inspection of the master-test jumper. VIAVI has a wide range of inspection tools include the P5000i fiber microscope and the FVAi/FVDi benchtop microscope.

Power Meter Connector Adaptors

VIAVI is committed to providing the latest power-meter adaptor interfaces. As connector formats change, new power-meter adaptors are required. VIAVI can provide mechanical specifications and drawings for specialized formats so that manufacturers can develop their own interface, as required. [For more information, you can find the AC adaptor selection guide with all currently available adaptors.](#)



Serviceability and After-care

In manufacturing applications, maintaining equipment and maximizing uptime is critical to profitability; the VIAVI Product and Service offerings for mORL-A1 and the MAP Series chassis were designed with this critical need in mind. With offerings ranging from factory service to onsite calibration and extended warranty, VIAVI is working to make product service as convenient and accessible as possible.

VIAVI has recently enhanced its services for the PCT systems which now include,

- 1. Return to the Factory:** An all-inclusive service option that includes functional testing, recalibration, implementation of necessary engineering changes, software upgrade, calibration sticker/cert and calibration report.
- 2. NEW Onsite Verification:** With this option, a VIAVI technician comes directly to the customer site and will perform functional test and (if necessary) calibration including a cert and calibration sticker.
- 3. NEW Onsite Calibration:** The customer receives all the same services as the Onsite Verification with the addition of a detailed report that identifies as received/final condition of the product as well as the detailed test results for each product tested.
- 4. NEW Onsite Maintenance:** This type of repair could include replacement of damaged adapters or ejector handles, and software updates.
- 5. Extended warranty:** Extend your hardware warranty and enjoy peace of mind in addition to budget predictability. Available at time of purchase or at any time up to the expiration of the OEM warranty, this offering facilitates quick turnaround and no repair charge in the event of an unforeseen hardware failure after the OEM warranty expiration.

For more information on services, visit the [dedicated PCT services page](#), contact your local VIAVI account manager or email technical support at support@viavisolutions.com.

Specifications

For more information on this or other products and their availability, please contact your local VIAVI account manager or VIAVI directly at 1-844-GO-VIAVI (1-844-468-4284) or to reach the VIAVI office nearest you, visit viavisolutions.com/contacts.

Parameter	Single-Mode mORL-A1	Multimode mORL-A1		
Source				
2-Wavelength Version	1310, 1550 nm	850, 1300 nm		
4-Wavelength Version	1310, 1490, 1550, 1625 nm	-		
Fiber Types				
Single Fiber	Single-Mode 9 μm core	50 μm core (OM3)		
Dual Fiber	-	50 μm core (OM3) and 62.5 μm core (OM1). Software selectable		
Measurement time				
Initializing Time	< 4s			
Averaging Options per wavelength	2, 5, 10s			
Insertion Loss				
Modes	-	LED or laser (software selectable)		
Display Resolution	0.001 dB			
Total IL Uncertainty ^{1,5,6}	± 0.02 dB	± 0.05 dB		
Additional uncertainties due to 1xN switching (if mOSW-C1 added)	± 0.01 dB			
Additional uncertainties due to fiber position in the integrating Sphere ²	± 0.03 dB			
Return Loss				
Display Resolution	0.01 dB			
DUT length				
DUT reflections (both ends) < 40 dB	> 170 cm			
DUT reflections (both ends) > 40 dB	> 70 cm			
Return Loss Repeatability^{3,4}	- 30 to 65 dB	± 0.1 dB	-15 to 60 dB	± 0.2 dB
	- 65 to 70 dB	± 0.2 dB		
	- 70 to 75 dB	± 0.4 dB	-60 to 70 dB	± 0.5 dB
	- 75 to 80 dB	± 1.5 dB		
Return Loss Accuracy³	- 30 to 70 dB	± 1.0 dB	-15 to 20 dB	± 1.8 dB
	- 70 to 75 dB	± 1.7 dB	-20 to 60 dB	± 1.3 dB
	- 75 to 80 dB	± 3.0 dB		
Recalibration Period	1 year			
Environmental Specifications				
Warm-up time	20 min			
Operating Temperature, humidity	25 \pm 5°C non-condensing humidity			
Storage Temperature	- 30 to + 60°C			
Physical Specifications				
Size (W x H x D)	4.06 x 13.26 x 37.03 cm (1.6 x 5.22 x 14.58 in)			
Weight (Approximately)	1.2 kg (2.65 lb)			

¹ After valid zero loss, total expanded uncertainty (2 σ), and reconnecting the same connector and OPM adaptor, temperature $\pm 1^\circ\text{C}$, using internal source.

² 24-channel ribbon fiber

³ All measurement specifications provided at 5 s averaging time and 200 m range, unless otherwise stated.

⁴ 10 measurements with a stable connection of a 3 m patch cord.

⁵ For LED mode, after valid zero loss, total expanded uncertainty (2 σ), and reconnecting the same connector and OPM adaptor, temperature $\pm 1^\circ\text{C}$, using internal source.

⁶ IL uncertainty from launching condition is not included.

Ordering Information

Insertion loss and Return Loss Modules

All PCT systems will require an IL/RL meter in a MAP-Series platform. Please consult the MAP-300 and the MAP-200 data sheets for more information on the platforms.

Type	Part Number	Description
Single Mode IL/RL Meter	MORL-A13500-STD-M100-MFA	IL/RL Meter 1310 /1550nm SMF FC/APC
	MORL-A13500-BID-M100-MFA	IL/RL Meter 1310/1550nm SMF Bidirectional FC/APC
	MORL-A13456-STD-M100-MFA	IL/RL Meter 1310/1490/1550/1625nm SMF FC/APC
	MORL-A13456-BID-M100-MFA	IL/RL Meter 1310/1490/1550/1625nm SMF Bidirectional FC/APC
Multimode IL/RL Meter	MORL-A11308-STD-M101-MFA	IL/RL meter 850/1300 nm 50um OM3 MMF FC/APC
	MORL-A11308-BID-M101-MFA	IL/RL meter 850/1300nm 50um OM3 MMF Bidirectional FC/APC
	MORL-A11308-BID-M112-MFA	IL/RL meter 850/1300 nm Dual Output OM3/OM1 MMF Bidirectional FC/APC
	MORL-A11308-STD-M112-MFA	IL/RL meter 850/1300 nm Dual Output OM3/OM1 MMF FC/APC

MAP-Series Switch Configurations

All mOSW-C1 switches are configured by a single part number that defines the function and options of the module. The **XXX** code defines the fiber type, as seen in Table 1, and the **YY** code defines the connector type, as seen in Table 2. For more switch options and specification details consult the mOSW-C1 data sheet.

Part Number	Description
MOSW-C111C004B0-MXXX-MYY	Single 1 x 4 switch, bulkheads
MOSW-C111C008B0-MXXX-MYY	Single 1 x 8 switch, bulkheads
MOSW-C111C012B0-MXXX-MYY	Single 1 x 12 switch, bulkheads (Dual width module)
MOSW-C111C024B0-MXXX-MYY	Single 1 x 24 switch, bulkheads (Dual width module)

Table 1

XXX code	Fiber Type
M100	9 μm Single Mode
M101	50 μm (OM3)
M102	62.5 μm (OM1)
M105	100 μm

Table 2

YY Code	Connector Type
MFP	FC/PC
MFA	FC/APC
MSC	SC/PC
MSU	SC/APC
MLC	LC/PC
MLU	LC/APC

MAP-Series Remote Power Head Configurations

Optional mOPM remote head can be added to the PCT system. The available configurations are in the table below. For more power meter options and specification details consult the mOPM-C1 data sheet.

Type	Part Number	Description
Remote Head Base Cassette	MOPM-C1RH1	Single channel remote interface cassette
	MOPM-C1RH2	Dual channel remote interface cassette
	MOPM-C1RH4	Quad channel remote interface cassette
Remote Head Options	MOPM-C1RHPCT	2mm InGaAs PCT system remote head
Integrated Remote Head Options	MOPM-C1RHIP	Integrated PCT system remote head

Software Options

VIAVI offers software licenses that can accompany your PCT system

Type	Part Number	Description
MAP-300 Family	MSUP-300A-FIT	MAP-300 Fiber connector inspection app - requires probe
	MSUP-300A-PCTMAPPING	MAP-300 PCT polarity and port mapping application add-on
	MSUP-300A-PCTREMDB	MAP-300 PCT remote centralized database connection key
	MSUP-300A-SBSC	MAP-300 PCT driver for legacy SB/SC series switches
	MSUP-300A-SEIL	MAP-300 Single Ended Insertion Loss license
MAP-200 Family	MSUP-FIT	MAP-200 Super Application Fiber Inspection (FIT)
	MSUP-PCTMAPPING	MAP-200 Super Application PCT Mapping
	MSUP-PCTREMDB	MAP-200 CT Remote Database Connection Key
	MSUP-SBSC	MAP-200 driver for legacy SB/SC series switches

Single Fiber Insertion Loss and Return Loss Test System

mOLM-C1 with PCT-rm Application Framework for MAP Series

PCT-rm is a MAP-220 based Insertion Loss (IL) and Return Loss (RL) solution targeting single fiber connector applications in the lab and in manufacturing. It is part of the broader MAP-Series Passive Connector Test (PCT) solution family which provides test solutions across the entire connectivity eco-system.

Building on the heritage of the classic JDSU RM and RX meters, the PCT-rm leverages the industry standard optical continuous wave reflection (OCWR) test method. A patented real-time measurement engine enables measurement performance and speed that is independent of the number of measured wavelengths. Production throughput is maximized independent of measurement need. A full range of power meter connector adapters ensures the unit can be configured for all connectivity applications.

The PCT-rm is part of the extended MAP LightTest family of solutions for passive components and optical connectors. The Light Test series provides application specific, integrated test solutions that leverage the power of the VIAVI MAP System. Built with specialized modules and assemblies of Light Direct Modules.

Key Benefits

- Real-time high repeatability system for IL and RL
- Multi-language, simple user interface enables direct deployment on production lines
- PCT Control Centre, a PC application simplifying data management and report printing
- Modular design supporting Multimode (EF compliant), Single-mode, and tunable sources

Applications

- Single fiber connector manufacturing
- Qualification testing of connectors and simple broad band passive components

Safety Information

- Complies to CE, CSA/UL/IEC61010-1, LXI Class C requirements, meets the requirements of IEC 60825-1 (2014) Class 1M and complies with 21 CFR 1040.1 except deviations per Laser Notice No. 50, July 2001



The PCT-rm is delivered by combining the mOLM-C1 measurement module with an mSRC-C2 source module in a MAP-220C chassis, giving users all the capabilities they need for IL & RL testing in a compact system.

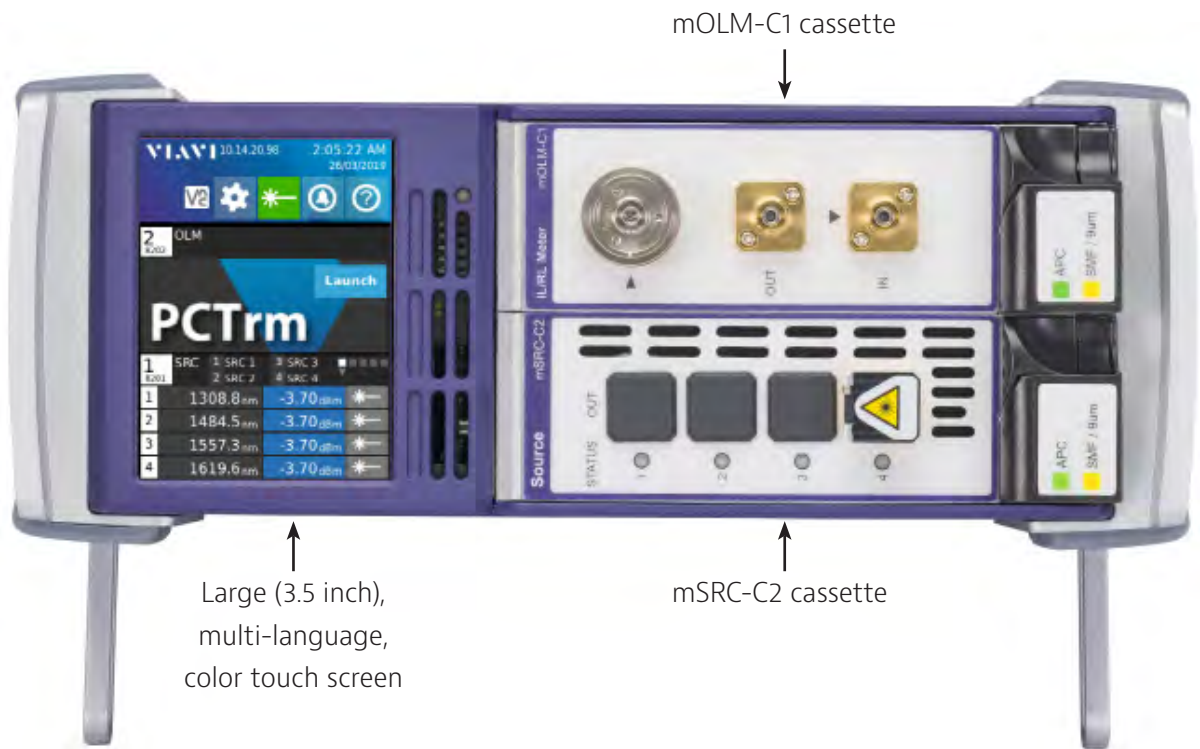

- Two slot, benchtop chassis gives customers full access to the broader MAP series system capabilities.
- LXI compliant LAN connectivity
- SCPI based remote commands over ethernet or an optional GPIB interface
- The PC based asset management tool enhances the ability to collect and centrally store data on remote network drives.
- Multiple USB ports enable the integration of a USB foot pedal device to creates a simple yet ergonomic solution for manufactures.

Measurement Modes

Instrument Mode

This measurement mode is designed to be always on and immediately available using the 3.5-inch LCD touch screen on the controller or through remote VNC. One touch referencing for IL and RL is simple and intuitive. Measurement resolution and averaging time are user controllable. The display can be configured to measure absolute power, insertion loss or insertion loss AND return loss.

Measurements are done in parallel with all 4 wavelength results reported in less than 0.5s. IL and RL are measured concurrently. A full range of on-board measurement management tools are available to manage source integration and calibration. In this mode, an external light source (like a tunable laser) can be configured and used.



Simple large display shown in single and multi-wavelength mode. The capacitive touchscreen enables quick and efficient navigation.

Device Aware Mode

Unlike other instruments in this performance class, the PCT-rm is delivered with a fully integrated workflow automation mode. DUT definition files and serial numbers can be pre-loaded to deliver a full production automation environment. Connecting the PCT-rm to your corporate or instrument LAN enables test results to be automatically uploaded to a shared directory. The DUT definition files can be centralized and shared amongst multiple units. If rework is required, results can be reloaded on any unit matching the hardware profile required to execute the test.

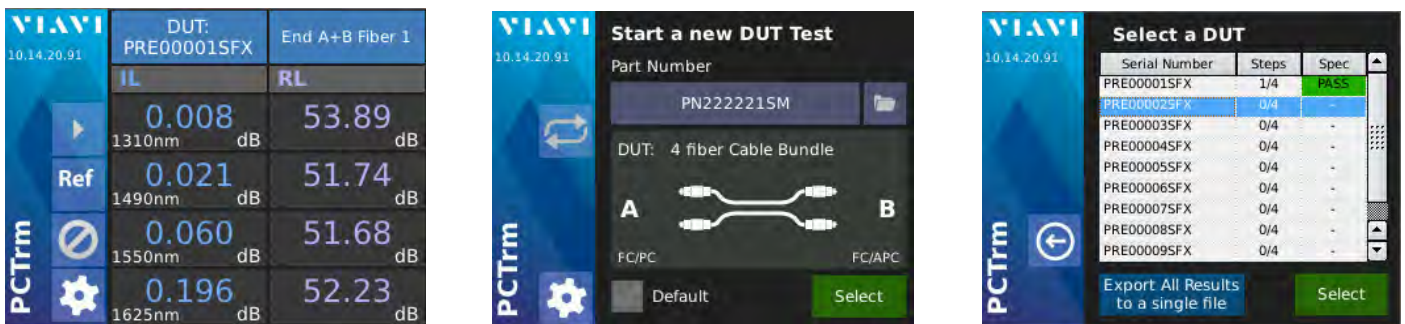

Example screens from DUT aware mode. Batch loads of serial numbers can be loaded. When testing the results can be frozen with a simple touch prior to uploading. Results may only be uploaded if they pass the DUT test criteria.

PCT Control Center

PCT Control Center is a free companion PC application, designed to maximize the value of the DUT Aware measurement mode. It is delivered standard with the PCT-rm.

A simple, easy to use PC interface enables creating, editing and managing DUT definition files, report templates and serial number batches. Files are saved to a shared directory and allows all PCT-rm units to use these files. If network connectivity is not available, USB storage media can be used to transfer the information. Test results can be uploaded, viewed, filtered and printed using both standard and editable HTML templates.

PCT Control Center is also compatible with the PCT-lite and PCTMax application which leverages the mORL-A1 measurement engine. Users who wish to migrate to mandrel-free testing, can continue to use the Control Center application and DUT files.

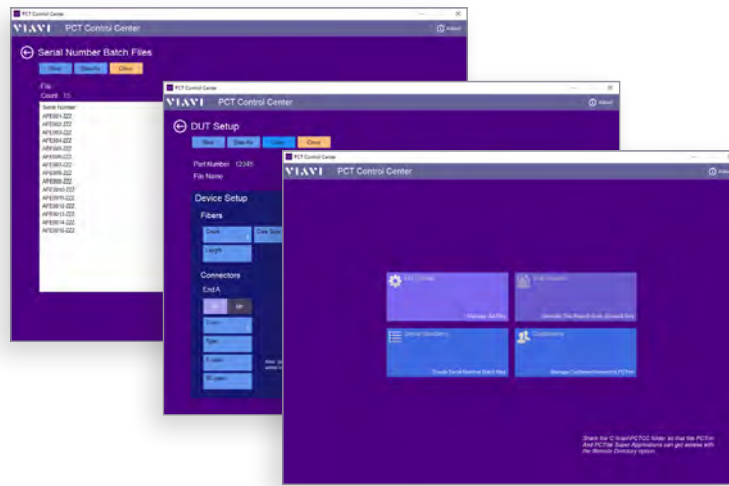

PCT Control Center is a simple PC application designed to simplify management of the PCT-rm and PCT-lite based IL and RL systems.

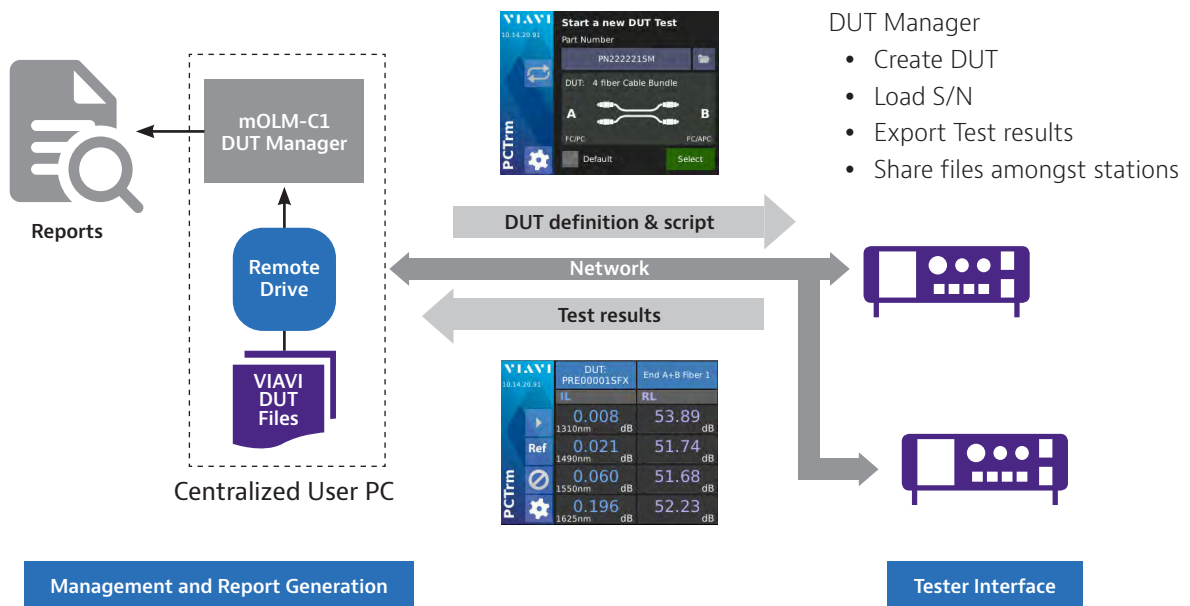

Multiple PCT-rm systems can share centrally managed and stored DUT definition files. Data is automatically uploaded to a shared directory and can be printed using the Control Center report engine.

Specifications

mOLM-C1 Cassette Optical Performance ¹		
Parameters	SMF	MMF (50um)
Wavelength		
Wavelength Combinations ²	1310 / 1550 nm 1310/1490/1550/1625nm	850 / 1300 nm
Wavelength accuracy	+/- 20 nm	
Multimode Launch conditions		As per IEC 61280-4-1
Power Meter		
Wavelength range	800-1650 nm	
Fiber Type	SMF and MMF with NA < 0.27	
Dynamic Range	+6 dBm to -70 dBm	
Display resolutions	0.001 dB	
Linearity	+/- 0.015 dB +/-5 pW	
Uncertainty at Reference Condition ³	+/- 3.0%	
Additional uncertainty due to polarization	+/- 0.015 dB	
Noise	+/- 3 pW	
Detector Return Loss (APC connector)	> 65 dB	
Insertion Loss⁴		
Max measurement speed (4 lambda)	All wavelengths measured in 0.5s Measured concurrently with Return Loss	
Display resolution	0.001 dB	
Display range	0 to -60 dB	
Accuracy (> -8dBm reference power)		
0 to - 40dB	+/- 0.04 dB	+/- 0.04 dB
-40 to - 50dB	+/- 0.05 dB	NA
Repeatability (> -10dBm reference power)		
0 to - 40dB	+/- 0.002	+/- 0.005
-40 to - 50dB	+/- 0.005	NA
Return Loss⁴		
Max measurement speed (4 lambda)	All wavelengths measured in 0.5s Measured concurrently with Insertion Loss	
Display dynamic range	10 to 80 dB	10 to 50 dB
Display resolution	0.01 dB	
Accuracy (> -8dBm reference power)		
10dB to 50dB	+/- 0.03 dB	+/- 0.3 dB
50dB to 65dB	+/- 0.4 dB	NA
65dB to -70dB	+/- 1.0 dB	NA
70dB to 75dB	+/- 2.0 dB	NA
Repeatability (> -10dBm reference power)		
10dB to 50dB	+/- 0.02 dB	+/- 0.3 dB
50dB to 65dB	+/- 0.4 dB	NA
65dB to 70dB	+/- 1.0 dB	NA
70dB to 75dB	+/- 2.0 dB	NA

1. All optical measurements performed 60 minutes after power on in a controlled environment of 23±2°C. All uncertainties are 2σ values unless otherwise stated. Specifications not guaranteed outside operating wavelength limit of the optical power meter. The mSRC-C2 and mOLM-c1 shall be connected with the rigid jumper supplied with the system.

2. Peak wavelength defined per IEC 61280-1-3 2010 clause 3.1.3.

3. Power meter reference condition: Input fiber SMF-28, T= 23 ±5°C, spectral width of source < 6nm, -20dBm input power

4. Tested in wavelength cycling mode using specified mSRC-C2, performed within 5min of an IL reference and observed over 15min, ignores any PDL contribution from DUT

Specifications Continued

Dimensions (W x H x D)	220 x 88.2 x 387 mm (8.66 x 3.47 x 15.24 in)
Weight	8 kg (17.6 lbs)
Controller	CPU ARM AM335x Linux OS 4GB user flash memory Field replaceable (co-packaged with Power supply)
Display	3.5-inch color screen 320 x 240 resolution
Remote interface	Ethernet 10/100/1000Base-T GPIB (optional)
USB device support	Keyboard, memory stick, foot pedal
Power and Safety	
Power Supply	100 to 240 V AC, 50/60 Hz Auto-switching Field replaceable (co-packaged with controller)
Power consumption	160 VA
Local Laser interlock	Software password controlled
Environmental	
Operating temperature	10 to 40°C
Storage temperature	-30 to 60°C
Relative humidity	5 to 85% noncondensing

Configurations and Ordering Information

The PCT-rm ships in a preconfigured package with all the required elements including the MAP-220C mainframe, mOLM-C1 measurement module and applicable mSRC-C2. Other configurations are possible. For more information on this or other products and their availability, please contact your local VIAVI account manager or VIAVI directly at 1-844-GO-VIAVI (1-844-468-4284) or to reach the VIAVI office nearest you, visit viasolutions.com/contacts.

Order Code ¹	MAP-220 IL/RL Meter Variants
Single Mode Fiber, Dual Wavelength	
MAP-RM-C13500FB-M100-MFA	1310/1550nm Basic FP laser, FC/APC
MAP-RM-C13500FP-M100-MFA	1310/1550nm FP laser with Temperature Control, FC/APC
MAP-RM-C13456FP-M100-MFA	1310/1490/1550/1625nm FP laser with Temperature Control, FC/APC
50um Multimode Fiber Solution	
MAP-RM-C11308LP-M101-MFA	850/1300nm LED 50um MMF EF compliant, FC/APC

1. All systems include the interconnection jumper to connect mSRC and mOLM modules and one FC style power meter adaptor

The table below highlights commonly ordered options and spare parts. In addition, a complete range of single ferrule, duplex, bare fiber power meter adaptors and matting sleeves are available. VIAVI also offers a range of connector inspection tools. For additional options please contact your VIAVI Solutions sales consultant.

Accessories (Optional)	Description
MAP-200CGPIB-A	GPIB Interface Option
MAP-200C01	Rack-mount conversion kit
MAP-200C02	Benchtop conversion kit
MAP-200CLD-A	Replacement LightDirect Controller
MAP-200A020	Hardened inter-connection jumper, SMF, FC/APC
MAP-200A021	Hardened inter-connection jumper, OM3, FC/PC
AC500	Replacement bulkhead adapter FC/PC
AC502	Replacement bulkhead adapter FC/APC



MAP-200A20 hardened interconnect jumper



Power meter adaptors

© 2020 VIAVI Solutions Inc.
 Product specifications and descriptions in this document are subject to change without notice.
 mOLM-c1-pct-rm-ds-lab-nse-ae
 30187741 900 0719

MAP Swept Wavelength System

(mSWS)

The new MAP-based Swept Wavelength System (mSWS-A2) is the next generation of an industry standard. More than 100 manufacturers around the world rely on the SWS to measure insertion loss (IL), polarization dependent loss (PDL), return loss (RL), and directivity as a function of wavelength in both research and development (R&D) and production environments. The new mSWS-A2 raises the bar on test speed, accuracy, and resolution, all while maintaining its patented distributed architecture to deliver the lowest-cost testing in the industry.

The mSWS System validates optical performance for the latest in optical components and modules including: colorless, directionless, contentionless (CDC) ROADMs, high-port-count wavelength switches, tunable filters, and circuit packs. Leveraging the capabilities of the current generation of SWS2000 tunable laser and source optics module (SOM), the new mSWS system now adds a next-generation measurement receiver based on VIAVI Solutions MAP-300 Photonics test platform.

With ± 0.002 nm absolute wavelength accuracy over the entire 1520 to 1630 nm range, the mSWS maintains its full performance specifications at 100 nm/s, which is double that of earlier generations. New variable wavelength resolution functionality has been added that lets users select the resolution from an unprecedented 0.4 to 3 pm.



Key Benefits

- Complete C and L band characterization of high-port-count devices in less than 5 seconds at maximum dynamic range with unprecedented wavelength resolution
- Patented parallel test architecture dramatically increases manufacturing output at a fraction of your initial investment
- Lets you compete in Next-Gen CDC device manufacturing
- Cuts floor-space requirements in half compared to previous SWS generations
- Maximize production up-time with local service options

Applications

Perform optical component and module characterization using these devices in both R&D and manufacturing environments:

- ROADMs, wavelength-selective switches, wavelength blockers
- Optical circuit packs
- Dense-wavelength-division multiplexers (DWDM)
- Tunable filters, couplers, splitters, switches, attenuators, interleavers
- Microelectromechanical systems (MEMs) and waveguide devices

Safety Information

Complies with CE requirements as well as UL3101.1 and CAN/CSA - C22.2 No. 1010.1. The laser source in the Source Optics Module (SWS20010) is Class 1. The Tunable Laser Source (SWS17101) is a Class 3B laser. Both the module and laser source are classified per IEC standard 60825-1(2002) and comply with 21CFR1040.10, except for deviations per Laser Notice No. 50, July 2001.



With a dynamic range of >70 dB, the mSWS provides industry-leading performance combined with low cost of ownership. The patented distributed architecture supports up to eight separate, individually-controlled measurement stations per source laser. Often purchased initially as an R&D tool, its measurement station scalability lets customers flexibly transition the equipment from R&D to production.

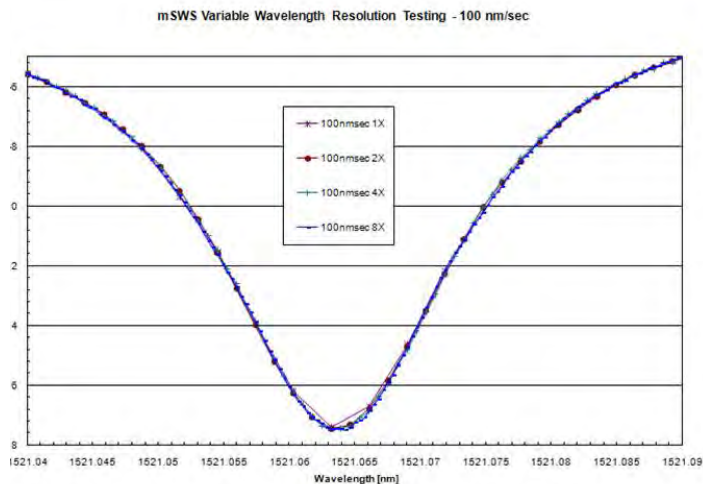

Figure 1. Example of ultra-high resolution where all data was collected at 100 nm/s sweep speed

Installed SWS2000 systems can be upgraded by adding new mSWS-A2-based measurement stations to maximize the benefit to existing SWS users within their existing capital infrastructure.

The SWS directly measures IL, PDL, and insertion loss as a function of wavelength and measures RL with the optional RL modules.



Figure 2. Example of mSWS interleaver scan

Using the raw IL and PDL data, the newly updated, easy-to-use application software's comprehensive set of analysis tools calculate these parameters relative to the measured peak, ITU grid, or user-defined grid:

- loss at peak
- center wavelength, from x dB threshold
- loss at center wavelength
- bandwidth at x dB threshold
- crosstalk, left/right, and cumulative
- flatness

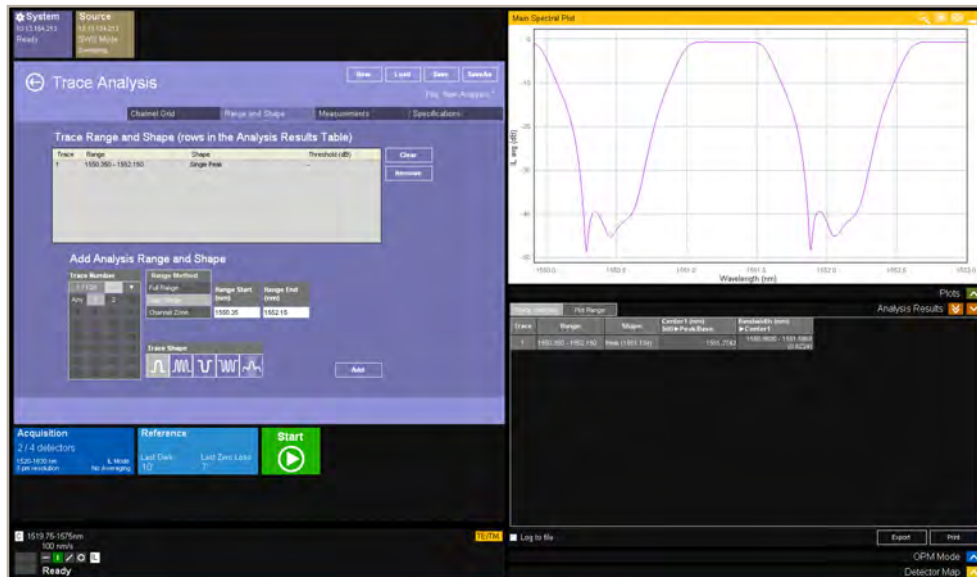

Figure 3. Improved software with easy-to-use analysis tools

The set of mSWS-A2 data link layers (DLLs) can be used to develop software for custom testing requirements. The DLLs function through the mSWS receiver hardware, allowing access to all SWS functionality. Using the supplied DLLs, users can develop applications in Visual Basic™, C, C++, or LabView environments.

With a 4-state polarization controller located within the SOM, PDL and average loss can be measured quickly as a function of wavelength. It can measure four polarization states at 0°, 90°, -45°, and circular polarization and uses the Mueller matrix analysis to accurately determine PDL at all wavelengths scanned.

Integrating the mSWS functions into the MAP-300 platform lets users access the full power of the MAP-300 application modules. Test systems can be automated with additional switches and laser sources. Fitting the MAP-300 with various connector inspection tools keeps dirty connectors from corrupting measurement results.

Specifications

Parameter	Specification	
Wavelength		
Range	1520.086 to 1630 nm	
Accuracy	±2 pm absolute	
Resolution	User selectable at 3, 1.5, 0.75, or 0.4 pm	
Measurement Time (all channels are measured in parallel)		
SOM sweep rates	10, 20, 40, and 100 nm/s	
Sweep periods (s)¹		
<i>C band time</i>		
10 nm/s	8	
20 nm/s	5.5	
40 nm/s	4	
100 nm/s	3	
<i>C L band time</i>		
10 nm/s	15	
20 nm/s	9	
40 nm/s	6	
100 nm/s	4	
Insertion Loss		
Measurement range²		
Stand-alone station	70 dB	
Distributed station	60 dB	
Noise ⁴ at 10 nm/sweep rate	0 to -20 dB	< ±0.005 dB
	-20 to -40 dB	< ±0.02 dB
	-40 to -50 dB	< ±0.05 dB
	-50 to -60 dB	< ±0.2 dB
Base uncertainty ³	±0.03 dB	
Resolution	0.001 dB	
Maximum slope tracking at 10 nm/s	0 to -60 dB IL	>0.4 dB/pm
Parameter	Specification	
Return Loss		
Measurement range ⁵	60 dB	
Noise ⁴ at 10 nm/s	0 to -20 dB	< ±0.02 dB
	-20 to -40 dB	< ±0.06 dB
	-40 to -50 dB	< ±0.2 dB
	-50 to -60 dB	< ±0.5 dB
PDL		
Measurement range ⁶	50 dB	
Noise ⁴ at 10 nm/s	0 to -20 dB	< ±0.01 dB
	-20 to -40 dB	< ±0.04 dB
	-40 to -50 dB	< ±0.1 dB
Resolution	0.001 dB	

1. In continuous scanning mode with delay set to zero and direct Ethernet connection; high-channel-count systems will require several seconds of delay

2. For > 10 dBm to DUT

3. Total IL uncertainty before noise or slope error, assuming SOM to mSWS-A2RX receiver fiber static, FC/PC connector to mSWS-A2DM detector, and temperature within ±1°C

4. Noise value is 3 X standard deviation

5. Requires ORL utility cassette, which is used in conjunction with mSWS-A2DM and mSWS-A2RX cassettes

6. At -10 dBm to DUT and a sweep rate of 10 nm/s; measurement range reduced at higher speeds

Ordering Information

mSWS Core System	
Description	Part Number
C+L band tunable laser	mSWS-A2SLS
Dual-output integrated source optic module (SOM)	mSWS-A2S0M
Four-output telemetry transmitter expansion module (SOM)	mSWS-A2TX
MAP-300 8-slot mainframe ¹	MAP-380
mSWS quad detector module	mSWS-A2DM
mSWS telemetry receiver	mSWS-A2RX
ORL utility cassette	mUTL-A1000 with option MUTL-A150LR
PM fiber jumper for mSWS	mSWS-PMJ
mSWS Optional Equipment and Accessories	
Detector cap	AC900
FC detector adapter	AC901
ST detector adapter	AC102
SC detector adapter	AC903
LC detector adapter	AC918
Bare fiber adapter holder	AC920
Bare fiber adapter (Includes one AC920)	AC921

¹Refer to MAP-300 data sheet for available mainframe options.

Optical Component Environmental Test System

The Certified VIAVI OCETS (Optical Component Environmental Test System) is the third generation of the classic OCETS, a solution customers have relied on for almost 30 years. With improved hardware specifications and software algorithms, the Certified VIAVI OCETS meets the latest market requirements for optical component qualification testing, such as those driven by the Verizon FOC program.

All standards require that a representative number of sample devices be subjected to a program of environmental stresses. Stress types include dwelling at high and low temperatures while maintaining target humidity levels, and cycling between temperatures. For example, an environmental test program can consist of numerous temperature and humidity pairings along with a series of mechanical tests. Device characteristics must be measured before and after each stage in the test program and, in some cases, continuously or at various intervals during a particular stage. Removing all the devices from the environmental chamber for optical measurements is simply not practical, and it is for this measurement requirement that the Certified VIAVI OCETS has been designed.



Benefits

- High Return Loss option (HiRL) monitors RL up to 70 dB
- Up to 320 device channels (640 ports)
- High insertion loss (IL) and return loss (RL) repeatability
- Full bidirectional testing
- Single-mode and multimode systems
- Supplied with EasyOCETS software

Applications

- Unattended long term monitoring of optical component IL and RL
- Measures parameters required in Telcordia standards such as GR-326-CORE, GR-910-CORE, GR-1435-CORE, GR-1209-CORE and GR-2866-CORE
- Verizon FOC qualification for components such as Jumpers, Cables, and Passive Splitters

Safety Information

- Complies to CE requirements. Switch and MAP based products comply to UL3101.1 and CAN/CSA-C22.2 No. 1010.1. MAP lasers are Class 1 except for 850 nm version which is Class 1M. The lasers are classified per IEC standard 60825-1(2002) and comply with 21CFR1040.10 except deviations per Laser Notice No. 50, July 2001.

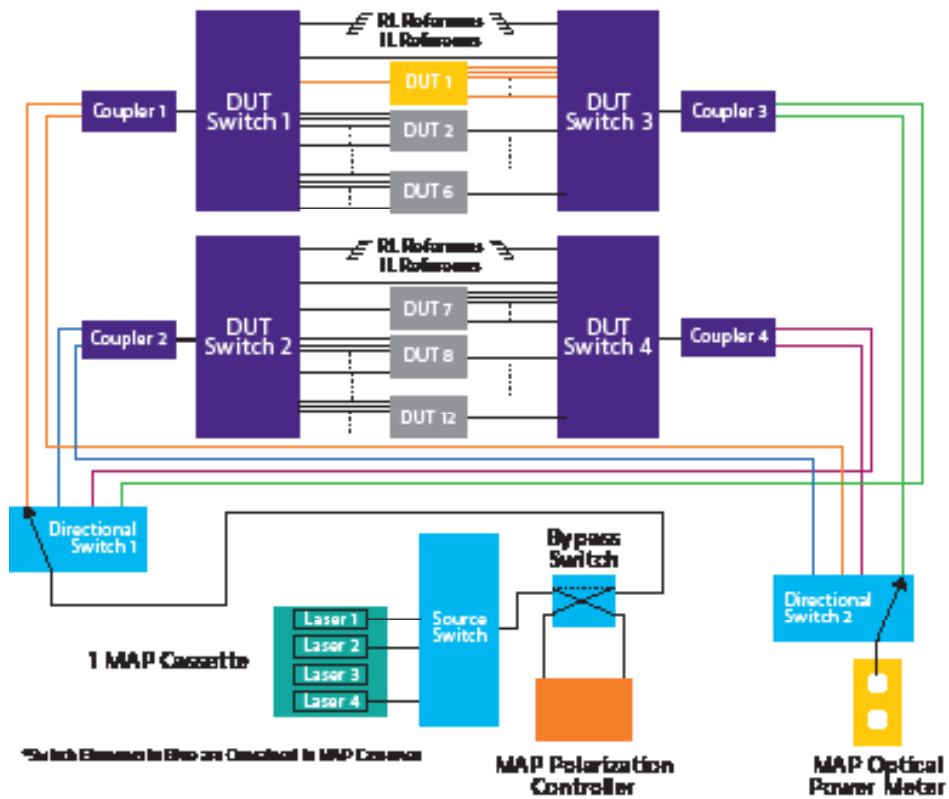
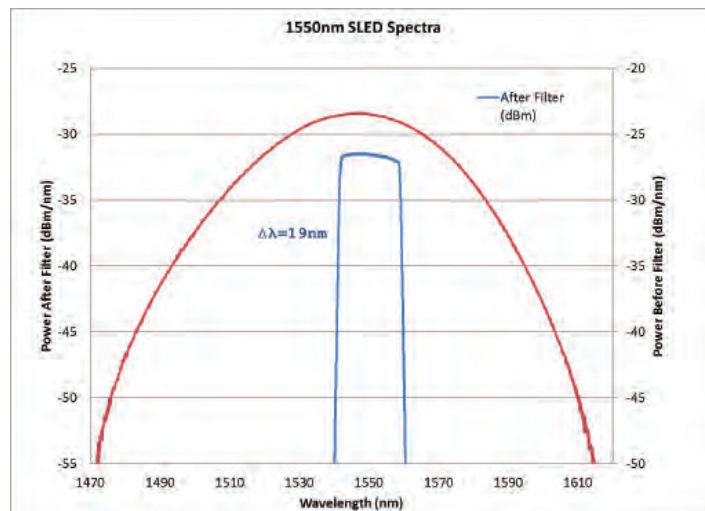

Figure 1. Bidirectional Test Configuration of 1x32 splitters, within a 320 channel (640 port) system

Optical Performance

The Certified VIAVI OCETS uses Super Luminescent Diodes (SLEDs)—carefully engineered light sources providing high power and short coherence length—to maximize overall system performance while maintaining strict adherence to wavelength and bandwidth standards. Minimizing coherence length is critical to long-term stability; however, the broad wavelength coverage can bias test results. To minimize bias, each SLED is individually filtered to create the ideal long-term test source.



For 30 years, VIAVI (and its former heritage as JDSU) has been the leader in optical switching for test and measurement applications. At the core of the Certified VIAVI OCETS is a pair of third-generation optical switches that are based on the MAP-200 MISW-C1 Optical Switch solution. The ultra-low loss and repeatability of these switches are key to the performance of the system. Specifically designed with beam traps to capture stray light, the MISW-C1 Optical Switch solution is optimized for return-loss stability.

The following examples of Insertion Loss and Return Loss in simple loopback mode demonstrate the system stability.

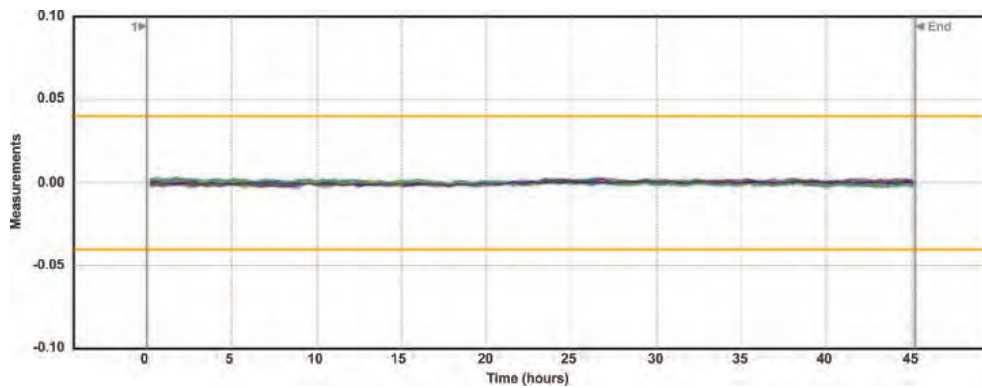

Figure 2. Insertion Loss

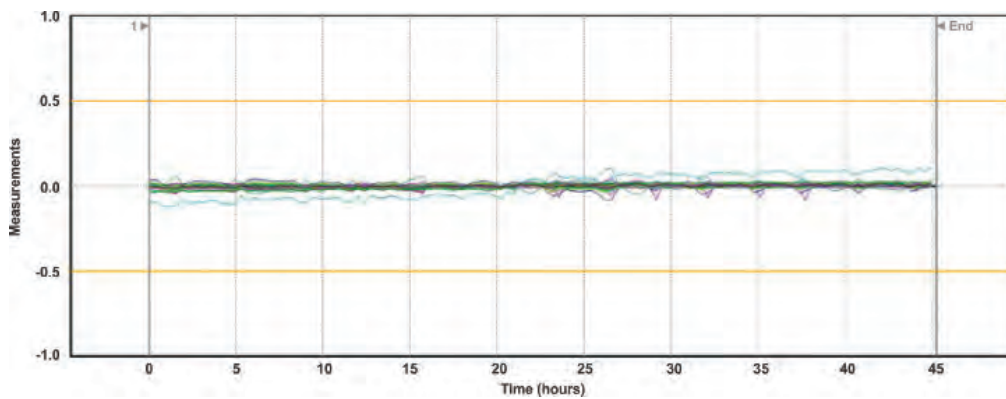
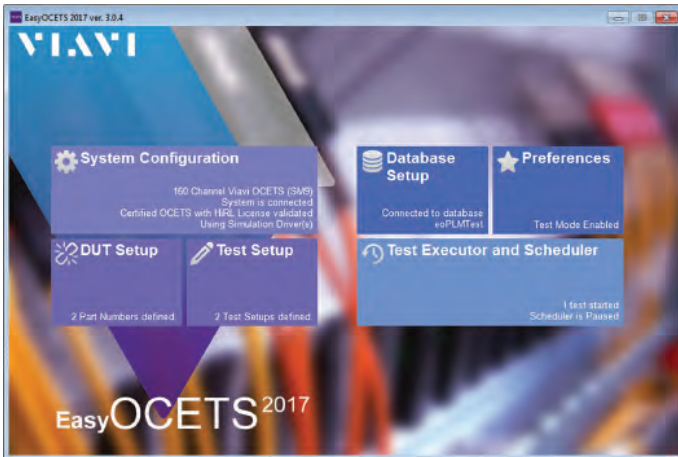

Figure 3. Return Loss

EasyOCETS2017 and EasyViewer 2017 Software

The VIAVI OCETS comes with two independent software packages. EasyOCETS2017 is the main control and data-collection interface. EasyViewer 2017 enables viewing and extraction of the data. Data is collected in an SQL database that can be remotely hosted anywhere on your network. All test files, DUT definitions and system configuration files are in the SQL database and can be shared between systems.

The Test Executor and Scheduler has been dramatically improved to allow multiple tests to be scheduled at the same time and provide greater flexibility for large-channel-count systems.



Simple, clear interface makes checking status or training new operators fast and efficient. Tool sets for adding setup instructions make creating tests simple and efficient. Central database allows data to be accessed anywhere and test scripts to be programmed remotely.

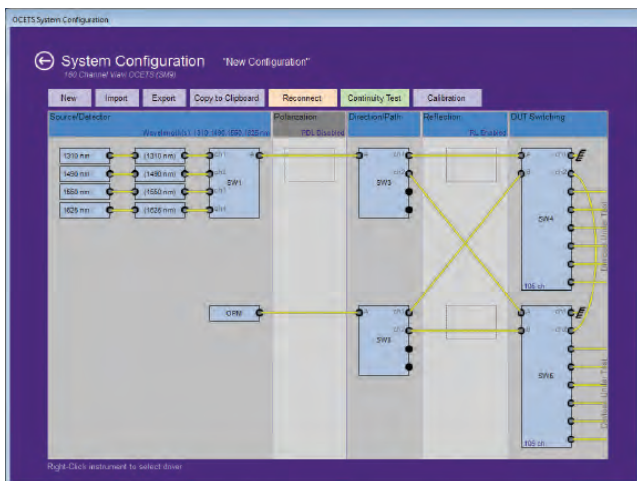

Visual guide to the test system is simple and intuitive. Simulation and continuity-check modes simplify set up.

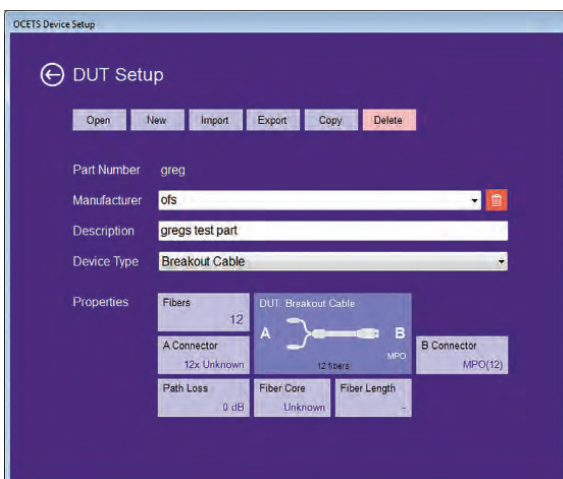

Device under test (DUT) libraries are created using a simple editor. Auto-channel-connection algorithms simplify creating test scripts.

Specifications

Parameter	Single-Mode (SM)	Multimode (MM)
Fiber Type	9/125 μm fiber, standard 3 mm jacket	50/125 μm fiber, standard 3 mm jacket
SC Switch Pigtail Lengths (to DUTs)	5 m per switch (10 m total between the two switches)	5 m per switch (10 m total between the two switches)
Insertion Loss (IL) dynamic range	>65 dB	>50 dB
Insertion Loss (IL) repeatability over 100 hours	± 0.04 dB for IL <50 dB	± 0.04 dB for IL <35 dB
Return Loss dynamic range	>70 dB	>35 dB
Return Loss (RL) repeatability over 100 hours	± 0.4 dB up to 55 dB With HiRL option: ± 1 dB up to 65 dB ± 3 dB up to 70 dB	± 0.4 dB up to 30 dB
Measurement Timing	IL, RL, HiRL <2.5 s ¹	IL, RL <2 s
Sources Available ²	1310, 1490, 1550, 1625 ± 10 nm SLED	850, 1300 ± 20 nm LED ³
Source Power Stability at 23°C	± 0.01 dB for 20 minutes	± 0.01 dB for 15 minutes
General		
Number of Channels ⁴	55, 105, 160, 210, or 320 input and output channels	
Number of Reference Channels ⁵	1 IL path, 1 RL path (per DUT switch)	
Equipment Warm-Up Time	4 hours, can be left on indefinitely with no adverse side effects	
Input Voltage	100V to 240V AC, 50/60 Hz auto-switching	
Power Consumption (includes computer)	55 to 160 channels: 750 VA; 210 to 320 channels: 950 VA	
Computer Control	Minimum configuration: Intel Core i3 CPU, 8GB RAM, 500GB HDD, 2 x 10/100G Ethernet interface, USB 2.0 port	
Mechanical Configuration	All equipment, except computer, is installed in a single bay, 32U, 19-inch rack with removable covers and door Cabinet includes top-mounted fans, casters and levelers W x H x D: 22 x 72 x 26 in (56 x 183 x 66 cm) Rear door access to MAP cassettes	
Weight	55 to 160 channels: 190 kg; 320 channels: 220 kg	
Operating Humidity	0 to 80% RH range. Maximum variation range during a test: 15% RH	
Operating Temperature	15 to 30°C range. Maximum variation within range during a test: 3°C	

Available Configurations

OCETS is available in 55, 105, 160, 210 or 320 channel configurations. Systems can be supplied with either FC/APC bulkhead connectors on the DUT switches, or with 10-meter unterminated pigtails. Single Mode systems have the option of High Return Loss (HiRL). The HiRL option is only available for systems supplied with 10-meter unterminated pigtails.

1. Averaged over 60 consecutive measurements, not including reference or saving to database.

2. Source stability is measured at full power, constant current mode in a controlled environment of 23 \pm 1°C.

3. Multimode launch conditions meet the requirements of IEC 61280-4-1 Ed. 2.0.

4. The number of channels refers to the number of input and output channels; for example, "55 channels" means 55 input and 55 output channels.

5. The RL reference as utilized in the EasyOCETS2017 software algorithms is a 0 dB reflector. Users may add RL references to other ports.

In addition, as many input and output ports as required for IL references can be utilized.

Part Numbers

Fiber Type	Measurements	Test Channels	System Part Number
Standard Single-mode	Insertion Loss and Standard Return Loss	55	MOCETS-A3055S0-M100-MXX
		105	MOCETS-A3105S0-M100-MXX
		160	MOCETS-A3160S0-M100-MXX
		210	MOCETS-A3210S0-M100-MXX
50um Multimode EF Compliant		320	MOCETS-A3320S0-M100-MXX
		55	MOCETS-A3055S0-M101-MXX
		105	MOCETS-A3105S0-M101-MXX
		160	MOCETS-A3160S0-M101-MXX
		210	MOCETS-A3210S0-M101-MXX
		320	MOCETS-A3320S0-M101-MXX
Standard Single-mode	Insertion Loss and High Return Loss	55	MOCETS-A3055H0-M100-MNC
		105	MOCETS-A3105H0-M100-MNC
		160	MOCETS-A3160H0-M100-MNC
		210	MOCETS-A3210H0-M100-MNC
		320	MOCETS-A3320H0-M100-MNC

When MXX is shown, the following options are available

MXX CODE	CONNECTOR TYPE
MFA	FC/APC
MNC	No Connectors

© 2020 VIAVI Solutions Inc.
 Product specifications and descriptions in this document are subject to change without notice.
 opticalcomponents-ocets-ds-fop-nse-ae
 30186399 902 0219

On Site Services



PCT Calibration

Protect your investment in a VIAVI PCT by ensuring it is always operating at its best. VIAVI provides multiple PCT Calibration Service options designed to align with diverse customer needs. In addition to standard Return to Factory calibration, options also exist for VIAVI to go directly onsite to customer locations thereby maximizing the uptime of these valuable assets. Customers can then further select from various Service Levels associated with the reporting detail they require.

Standards

Instruments are calibrated based on general requirements for the competence of calibration and testing laboratories (ISO/IEC 17025:2005) using applicable VIAVI Solutions procedures, IEC 61280-4-1, IEC 61280-4-2 and IEC 62614 guidance. Results are traceable to French National Standards and NIST which are consistent with the recommendations of the General Conference on Weights and Measures (CGPM), or to standards derived from natural constants, or to standards relying on ratio measurements with self-calibrating technique for their calibration. Calibration procedures are VIAVI Solutions developed and to ensure best practices and standards throughout the VIAVI Service Network. Service Reports include document control numbers for processes and procedures.

Overview

VIAVI offers Onsite and Return to Factory options that allows customers to select the offering that works best for them.

- Conduct a top-level functional test of the instrument to verify that vital functions perform as expected
- Inspect and clean the optics and optical connections
- Verify to traceable standards the measurement accuracy of test instruments
- Document findings with a report of observations, measurements and actions
- Update calibration dates and/or provide calibration label noting date of calibration and due date for next calibration (after consultation with customer)
- Perform instrument and module maintenance to extend product lifetime
- Perform software updates



Services

Onsite Verification

For customers that are unable to return their product to VIAVI for service, VIAVI offers an onsite validation service. With this option, a VIAVI technician comes directly to the customer site and will perform functional test and (if necessary) calibration including a cert and calibration sticker.

Onsite Calibration

This offers an upgrade to the level of service received for customers opting for onsite services. With the Onsite Calibration, the customer receives all the same services as the Onsite Verification with the addition of a detailed report that identifies as received/final condition of the product as well as the detailed test results for each product tested.

Return to Factory

Return to Factory service is a comprehensive Service option that includes, functional testing, recalibration (if necessary), implementation of necessary engineering changes, software upgrade, calibration sticker/cert and calibration report. This option is available for all currently support PCT products, mainframes and modules.

Onsite Maintenance

In some cases, minor repairs can be done onsite at the customer location during an onsite calibration or verification engagement. This type of repair could include replacement of damaged adapters or ejector handles, and software updates. For cases where products need to be returned to the Factory for repair, VIAVI personnel can help to ensure that returned products have accurate information to ensure efficient processing.

PCT	Onsite	Factory
Calibration		
IL Verification	●	●
IL Linearity Verification	●	●
RL Accuracy Verification	●	●
RL Linearity Verification	●	●
IL Calibration		●
IL Linearity Calibration		●
RL Accuracy Calibration		●
RL Linearity Calibration		●
Laser Calibration		●
OTDR Pulse Calibration		●
Optical Detector Calibration		●
Reflectance Calibration		●
Apply Calibration Sticker	●	●
Provide Calibration Certificate	●	●
Provide Calibration Report	○	●
Maintenance/Repair		
Inspect unit for damage	●	●
Inspect and clean connectors	●	●
Confirm unit operational	●	●
Voltage check - laser/APD/circuitry		●
FW/SW updates	○	●
Repair of non-functional products		●
Minor repairs	○	●
Cleaning	○	●

● Always included

○ Optional item

PCT Service Table

The following products are currently supported. For hardware not on the list or to obtain additional information, please contact your local VIAVI Services representative.

Applicable Products
MORL-A13500-MSTD
MORL-A13500-MBID
MORL-A13456-MSTD
MORL-A13456-MBID
MORL-A11308-MSTD-M101
MORL-A11308-MBID-M101

mSWS Calibration

Protect your investment in a VIAVI mSWS by ensuring it is always operating at its best. VIAVI provides multiple Calibration Service options designed to align with diverse customer needs. In addition to standard Return to Factory calibration, options also exist for VIAVI to go directly onsite to customer locations thereby maximizing the uptime of these valuable assets. Customers can then further select from various Service Levels associated with the reporting detail they require.

Standards

Instruments are calibrated based on general requirements for the competence of calibration and testing laboratories (ISO/IEC 17025:2005) using applicable VIAVI Solutions procedures, IEC 61280-4-1, IEC 61280-4-2 and IEC 62614 guidance. Results are traceable to French National Standards and NIST which are consistent with the recommendations of the General Conference on Weights and Measures (CGPM), or to standards derived from natural constants, or to standards relying on ratio measurements with self-calibrating technique for their calibration. Calibration procedures are VIAVI Solutions developed to ensure best practices and standards throughout the VIAVI Service Network. Service Reports include document control numbers for processes and procedures.

Overview

SWS systems are often distributed and complex pieces of integrated test infrastructure and are part of an active production environment. For these reasons, returning systems or portions of systems to the factory for calibration is not always an attractive or even a viable alternative. VIAVI now offers Onsite, in addition to Return to Factory options for most SWS components to allow customers to select the offering that works best for their needs.

- Conduct a functional test of the system to verify that vital functions perform as expected
- Inspect and clean the optics and optical connections
- Verify measurement accuracy to traceable standards
- Document findings with a report of observations, measurements and actions
- Update calibration dates and/or provide calibration label noting date of calibration and due date for next calibration (after consultation with customer)
- Perform instrument and module maintenance to extend product lifetime
- Perform software updates



Services

Onsite Verification

For customers that are unable to return their product to VIAVI for service, VIAVI offers an onsite validation service. With this option, a VIAVI technician comes directly to the customer site and will perform functional test and (if necessary) calibration including a cert and calibration sticker.

Onsite Calibration

This offers an upgrade to the level of service received for customers opting for onsite services. With the Onsite Calibration, the customer receives all the same services as the Onsite Verification with the addition of a detailed report that identifies as received/final condition of the product as well as the detailed test results for each product tested.

Return to Factory

Return to Factory service is a comprehensive Service option that includes, functional testing, recalibration (if necessary), implementation of necessary engineering changes, software upgrade, calibration sticker/cert and calibration report. This option is available for all currently supported SWS products, mainframes and modules.

Onsite Maintenance

In some cases, minor repairs can be done onsite at the customer location during an onsite calibration or verification engagement. This type of repair could include replacement of damaged adapters or ejector handles, and software updates. For cases where products need to be returned to the Factory for repair, VIAVI personnel can help to ensure that returned products have accurate information to ensure efficient processing.

mSWS	Onsite	Factory
mSWS-SOM		
Laser Source Cassette		
Calibrate and Verify the 4SPC		●
Firmware Load		●
Cassette Initialization (SN/Rev/etc)		●
Wavelength Verification	●	●
Wavelength Calibration		●
PDL Verification		●
mSWS-A2TX		
Firmware Load		●
Cassette Initialization (SN/Rev/etc)		●
Run Self test	●	●
Verify 1310nm output power		●
Verify IL	●	●
mSWS-A2RX		
Firmware Load		●
Cassette Initialization (SN/Rev/etc)		●
Run Self test	●	●
Power Reference Linearity Calibration	●	●
Power Reference Linearity Verification	●	●
Verify IL		●
mSWS-A2DM		
Firmware Load		●
Cassette Initialization (SN/Rev/etc)		●
Run Self Test	●	●
Power Reference Linearity Calibration	●	●
Power Reference Linearity Verification	●	●
General		
Provide Calibration Certificate	●	●
Provide Calibration Report	○	●
Apply Calibration Sticker	●	●
Maintenance/Repair		
Inspect Unit for Damage	●	●
Inspect and Clean Connectors	●	●
Confirm Unit Operational	●	●
FW/SW Updates		●
Repair of Non-functional Products		●
Minor Repairs	○	●
Cleaning	○	●

● Always included

○ Optional item

SWS Service Table

The following products are currently supported. For hardware not on the list contact or to obtain additional information, please contact your local VIAVI Services representative.

Applicable Products
mSWS-SOM
mSWS-A2LS
mSWS-A2TX
mSWS-A2RX
mSWS-A2DM

OCETS Calibration

Protect your investment in a VIAVI OCETS by ensuring it is always operating at its best. VIAVI provides multiple OCETS Calibration Service options designed to align with diverse customer needs. In addition to standard Return to Factory calibration, options also exist for VIAVI to go directly onsite to customer locations thereby maximizing the uptime of these valuable assets. Customers can then further select from various Service Levels associated with the reporting detail they require.

Standards

Instruments are calibrated based on general requirements for the competence of calibration and testing laboratories (ISO/IEC 17025:2005) using applicable VIAVI Solutions procedures, IEC 61280-4-1, IEC 61280-4-2 and IEC 62614 guidance. Results are traceable to French National Standards and NIST which are consistent with the recommendations of the General Conference on Weights and Measures (CGPM), or to standards derived from natural constants, or to standards relying on ratio measurements with self-calibrating technique for their calibration. Calibration procedures are VIAVI Solutions developed to ensure best practices and standards throughout the VIAVI Service Network. Service Reports include document control numbers for processes and procedures.

Overview

OCETS systems are large, heavy and complex pieces of integrated test infrastructure. For this reason, returning systems or portions of systems to the factory for calibration is not always an attractive or even a viable alternative. VIAVI now offers Onsite in addition to Return to Factory options that allow customers to select the offering that works best for their needs.

- Conduct a functional test of the system to verify that vital functions perform as expected
- Inspect and clean the optics and optical connections
- Verify measurement accuracy to traceable standards
- Document findings with a report of observations, measurements and actions
- Update calibration dates and/or provide calibration label noting date of calibration and due date for next calibration (after consultation with customer)
- Perform instrument and module maintenance to extend product lifetime
- Perform software updates



Services

Onsite Verification

For customers that are unable to return their product to VIAVI for service, VIAVI offers an onsite validation service. With this option, a VIAVI technician comes directly to the customer site and will perform functional test and (if necessary) calibration including a cert and calibration sticker.

Onsite Calibration

This offers an upgrade to the level of service received for customers opting for onsite services. With the Onsite Calibration, the customer receives all the same services as the Onsite Verification with the addition of a detailed report that identifies as received/final condition of the product as well as the detailed test results for each product tested.

Return to Factory

Return to Factory service is a comprehensive Service option that includes, functional testing, recalibration (if necessary), implementation of necessary engineering changes, software upgrade, calibration sticker/cert and calibration report. This option is available for all currently supported OCETS products, mainframes and modules.

Onsite Maintenance

In some cases, minor repairs can be done onsite at the customer location during an onsite calibration or verification engagement. This type of repair could include replacement of damaged adapters or ejector handles, and software updates. For cases where products need to be returned to the Factory for repair, VIAVI personnel can help to ensure that returned products have accurate information to ensure efficient processing.

OCETS	Onsite	Factory
Cassette Level		
Laser Source Cassette		
Wavelength Accuracy Verification	●	●
Absolute Power Calibration		●
Absolute Power Verification	●	●
Power Stability Verification		●
OPM Cassette		
Absolute Power Calibration		●
Absolute Power Verification	●	●
Power Linearity Calibration		●
Power Linearity Verification	●	●
Noise Verification		●
System Level		
Power Level at DUT Channel		●
Switch Channel IL Level Verification		●
Switch Channel RL Level Verification		●
IL Linearity Verification	●	●
RL, HiRL Accuracy Verification		●
RL, HiRL Linearity Verification	●	●
HiRL Calibration (for HiRL system only)		●
100h IL Repeatability Verification		●
100h RL Repeatability Verification		●
General		
Provide Calibration Certificate	●	●
Provide Calibration Report	○	●
Apply Calibration Sticker	●	●
Maintenance/Repair		
Inspect Unit for Damage	●	●
Inspect and Clean Connectors	●	●
Confirm Unit Operational	●	●
FW/SW Updates		●
Repair of Non-functional Products		●
Minor Repairs	○	●
Cleaning	○	●

● Always included

○ Optional item

OCETS Service Table

The following products are currently supported. For hardware not on the list contact or to obtain additional information, please contact your local VIAVI Services representative.

Applicable Products
MOCETS-A3055S0-M100-Mxx
MOCETS-A3105S0-M100-Mxx
MOCETS-A3160S0-M100-Mxx
MOCETS-A3210S0-M100-Mxx
MOCETS-A3320S0-M100-Mxx
MOCETS-A3055H0-M100-Mxx
MOCETS-A3105H0-M100-Mxx
MOCETS-A3160H0-M100-Mxx
MOCETS-A3210H0-M100-Mxx
MOCETS-A3320H0-M100-Mxx
MOCETS-A3055S0-M101-Mxx
MOCETS-A3105S0-M101-Mxx
MOCETS-A3160S0-M101-Mxx
MOCETS-A3210S0-M101-Mxx
MOCETS-A3320S0-M101-Mxx

CleanBlastPRO

Next-generation fiber optic end-face cleaning system

CleanBlastPRO™ is the latest automated fiber end-face cleaning system from VIAVI Solutions. Based on the original concept from its predecessor, the CleanBlastPRO has been redesigned from the ground up to deliver all the benefits of the original CleanBlast while adding improvements where they matter most. The result is a system that component and connectivity manufacturers and integrators can easily deploy throughout their production facilities to ensure clean fiber connectors.

Equipped with an internal solvent tank, air filtration system, cleaning handset, 6-foot umbilical and an LCD screen, CleanBlastPRO gives users an intuitive and automated fiber connector cleaning system that can be easily deployed. Once the CleanBlastPRO is attached to an air source, the user can clean a wide variety of fiber end faces.



Key Benefits

- Ensure clean fiber end-faces for every connector type
- Streamline cleaning workflows in production environments with fast cleaning cycles
- Automate connector cleaning at the push of a button
- Remove, rather than spread or embed, loose debris from end faces
- Reduce costly consumption of cleaning materials (cloths, clickers, swabs, etc.)
- Utilizes 3M Novec™ 72DA, the industry's most trusted and effective solvent for cleaning fiber end faces

Applications

- Optical component production environments
- Cable assembly contract manufacturing
- Optical system assembly

Key Features

- Uses a precise non-contact air-solvent-air sequence to blast and remove contamination particles
- Comprehensive selection of precision cleaning tips for most fiber connector types
- High performance air filter system
- Hassle-free solvent management
- Additional connections for secondary air tank, foot activation pedal, backplane handset extension

Streamline connector cleaning workflow with a repeatable automated process

CleanBlastPRO gives component and connector manufacturers control of the cleaning process throughout their entire production facilities. This automated system manages the fluid and air delivery to ensure fast and repeatable cleaning at the press of a button.

- Dedicated cleaning profiles are optimized for different connector types. Each profile delivers a series of precision air, solvent, and vacuum steps that are fine-tuned to the millisecond for optimal cleaning performance.
- CleanBlastPRO monitors the status so that you can proactively ensure it is properly maintained.
- You're never surprised of the system's status, so it won't take your production line down.



Figure 1a: Select Profile

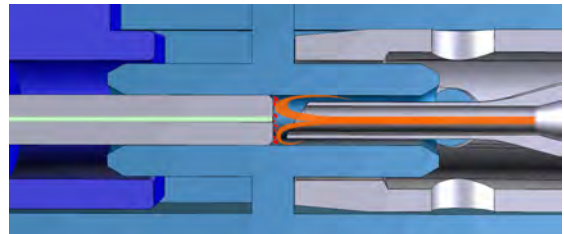
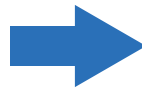

Figure 1b: Optimized non-contact cleaning procedure

Handset and Cleaning Tips

- Front facing light provides optimized visibility when inserting
- Two configurable buttons (top and bottom) to activate the light and initiate the cleaning process
- An optional extension handle is also available for use with backplane applications
- Additional connections for foot activation pedal, backplane handset extension, USB3 input for device updates
- Features a comprehensive selection of precision cleaning tips for most fiber connector types, male (patch cord), female (bulkhead), PC and APC – including SC, LC, FC, ST, E2000, MPO, MPX, MT, SMA, HMFOC, SN, CS and more
- With backwards compatibility to the large selection of FCLT series tips, existing CleanBlast users can leverage their existing investment of cleaning tips
- For a complete list of tips for the CleanBlastPRO see the [Fiber Cleaning Tips and Adapters Selection Guide](#)



Figure 2: Examples of FCLT Series Cleaning Tips

New hassle-free management features make deployment and operation easy

The CleanBlastPRO controls are intuitive so that users can easily manage their cleaning profiles and receive information and notifications to ensure system care. With multiple on-board sensors, CleanBlastPRO actively monitors the system performance, ensuring that users are proactively informed of any maintenance needs, and can properly care for the system and plan ahead without guesswork, speculation or unwanted production line downtime.



Figure 3: Front panel indicators and controls

- On-board LCD screen provides key user information for all operational and maintenance needs, including managing cleaning profiles, refilling, gathering diagnostic information and upgrading
- Colored LED indicators inform users when system is ready for use or in need of maintenance.
- Fuel gauge indicates amount of solvent available

All interface connections on the CleanBlastPRO are standardized to accept 3rd party connectivity; including the following:

- ¼" input on the base unit (for foot-pedal activation)
- 3.5mm input on the handset (for backplane handset extension)
- Camera mount attachments on handset (for single-hand operation)
- Standard 12VDC/2A Power Supply
- USB3 input for device updates



Figure 4: Solvent refill

- Spill-proof internal solvent tank ensures easy transport across the room or across the globe, even with a full solvent tank
- Automatic filter drain prevents moisture from collecting in filters in humid environments
- Automatic drain valves in air-filter canisters prevent condensation in the air supply from contaminating the system.
- Active fluid vapor vacuum keeps fumes away from operator.
- Front-facing ports enable easy solvent refilling of the entire tank in <2 minutes
- Sealed refill system prevents external contaminants from entering the filling system. This prevents cleaning system from distributing contaminants onto the connector
- System automatically ensures sufficient refill without overfilling

Specifications

Parameter	Description
Air/Gas Source	Clean, dry air ¹ or nitrogen (N ₂)
Air/Gas Pressure	80 to 140 psi, 100 psi nominal ^{2,3}
Air/Gas Inlet	1/4" Industrial Quick-Disconnect Coupling ⁴
Internal Solvent Tank Capacity	1 L
Input Power	12V DC, 2A Power Supply (included) ⁵
Power Consumption (Average)	< 12 W
Operating temperature	15 to 30°C (59 to 86°F)
Storage temperature	0 to 40°C (32 to 104°F)
Dimensions	8" x 8" x 13" (H x W x D), 203mm x 205mm x 329mm (H x W x D)
Weight	30lbs (with full tank), 13.6 kgs
Maintenance	Annual filter change recommended Requires two air filters: <ul style="list-style-type: none"> • One Coarse air filter (FCLP-FA-F2) • One Fine air filter (FCLP-FA-F3)
Cleaning Cycle Time	Simplex <1 second Multi-Fiber <1.5 seconds

¹As per ISO8573 Class 5 -Clean Dry Air. (Oil less than 25mg/m**3).

²CleanBlastPRO will continue to operate when pressure is between 50 to 80 psi; however, cleaning might be impaired.

³Pressure relief safety mechanism activates when pressure exceeds 150 psi and resets when air-source connection is removed.

⁴Fitting can be replaced with any 1/4" NPT Male fitting.

⁵Use only the power adapter shipped with the CleanBlastPRO to power the device.

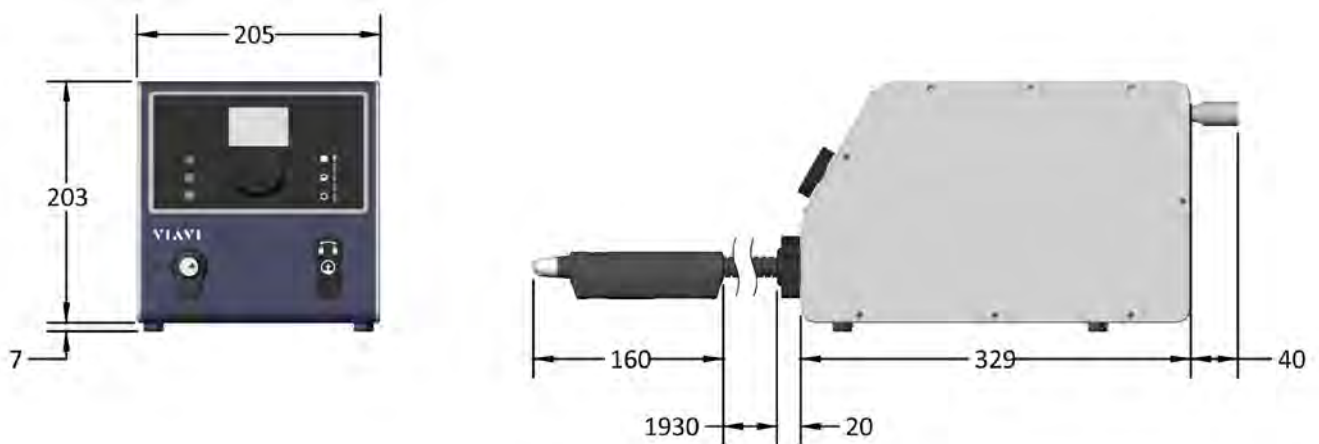

Figure 5: CleanBlastPRO dimensions

Ordering Information

Description	Part Number
CleanBlastPRO Systems	
CleanBlastPRO System with large internal solvent tank, FCLT-U25 cleaning tip	FCL-PRO-L
Accessories	
Manual Refill Kit for 225 ml Solvent Refill Bottle	FCLP-RCA-2
Auto Refill Kit for 1 Gallon (3.8L) Solvent Refill Bottle	FCLP-RCA-3
Replacement Air Filter for Auto Refill Kit (FCLP-RCA-3), contains 1 filter	FCLP-FA-F1
Small Solvent Refill Bottle, 225ml*	FCLP-SOL1
Small Solvent Refill Bottle, 6-pack, 225ml	FCLP-SOL1-6
Large Solvent Refill Bottle, 1 Gallon (3.8L) **	FCLP-SOL1-XL
Replacement Coarse (5 micron) Filter Kit (contains 2 filters)	FCLP-FA-F2
Replacement Fine (0.1 micron) Filter Kit (contains 2 filters)	FCLP-FA-F3
Exhaust Filter Kit	FCLP-FE-01
Cleaning Tips***	
Universal 2.5 mm bulkhead	FCLT-U25
Universal 2.5 mm patch cord mating adapter	FCLT-U25-MA
Universal 1.25 mm bulkhead	FCLT-U12
Universal 1.25 mm patch cord mating adapter	FCLT-U12-MA

* Small (225ml) solvent refill bottles available from VIAVI or MicroCare

** Large (1 Gallon/3.8L) solvent refill bottles available from VIAVI, MicroCare, or 3M

*** For a complete list of tips for the CleanBlastPRO see the [Fiber Cleaning Tips and Adapters Selection Guide](#)

Important: CleanBlastPRO is rated for use with 3M Novec 72-DA Engineered Fluid. Use only Novec 72DA solvent from 3M or CleanBlast solvent from MicroCare Corporation (identical formulation to Novec 72DA). Warranty will be void if a VIAVI repair center or representative determines that any other solvent has been used and is the cause of operational problems.



Contact Us **+1 844 GO VIAVI**
(+1 844 468 4284)

To reach the VIAVI office nearest you,
visit [viavisolutions.com/contacts](https://www.viavisolutions.com/contacts).

© 2020 VIAVI Solutions Inc.
Product specifications and descriptions in this
document are subject to change without notice.
optical-lab-man-ct-fop-nse-ae
30191137 901 1120